



FLOORING INSTALLATION
PRODUCTS

CATALOG No. 47

FLOOR DOT[®]

install with pride!

By:

TEGO[®]
SYSTEMS 

Pages

3
4-7
8-15
16-19
20-21
22
23
24-25
26-27
28
29
30-31

Product Categories

Index
Moisture/Distance Meters & Concrete Restoration
Carpet & Blades
VCT, Vinyl & Heat Welding
Laminate & Hardwood Accessories
Ceramic
Warranty
Pro Nails & Pro Hammers
Fastening
Seaming Tape
Abrasives
Pro Floor Protection



Leaders in Quality, Supply Chain & Value

We are committed to the manufacturing and marketing of innovative, high quality flooring installation products.

Hydra RH Contractor Kit™
T03-0220



- Fully comprehensive
- Extremely accurate
- Lowest cost
- Highest efficiency
- Compliant with all ASTM F2170

Wood & Concrete Moisture Meter
T03-0200



- Non-Invasive
- For wood, concrete & gypcrete
- Measuring depth 1 1/4"
- Very affordable

Self Leveling Roller with
Splashguard

- T03-0153-20 - 20", 500 mm width
- Spike length 21mm



Deluxe Pulling Claw
T03-0091



Nail Shoes
T03-0170



Hydra RH Sensor Probe™
T03-0220-1



Hydra RH Sleeves™

- T03-0220-2 Bag of 5
- T03-0220-3 Bag of 10
- T03-0220-4 Bag of 20



33' Pro Measuring Tape
T03-0300



4" Pro Scraper Series

- Fits all 4" blade styles
- Heavy duty 1" diameter tube
- Can be used with a hammer
- Comfort grip handle

- T03-0011 12" long
- T03-0012 20" long
- T03-0013 48" long

Blade Clamp w/ Screws
T03-0011-1



Blades used:
T04-3027
T04-3030

Spud Bars

- Heavy duty steel tube design
- D-Grip handle
- 56" long

- T03-0021 3.5" Blade
- T03-0022 7" Blade

Replacement Blades

- T03-0021-1 3.5"x4" Blade
- T03-0022-1 7"x4" Blade



Just Push Cutter

T03-0050

Blade used:

T04-3021

Replacement Pin:

T03-0050-1



8" Extendable Floor Scraper

T03-0016

Blade used:

T04-3032



Blade Clamp
w/ Screws
T03-0016-1

6" Heavy Duty Extendable Scraper

T03-0019

- To be used with 04-0201
Stretcher Poll

Replacement Blade

T03-0019-1



Pro Stripper™
110V, 60Hz, 2.7 hp
6500 rpm

T03-1010

- Includes T-handle and Snap-On wheels
- Fast and clean removal of:
 - Glue-Down Carpet
 - VCT
 - Linoleum



Replacement Stripper Blades

8 1/4" x 2 1/3"
T03-1010-1



8 1/4" x 5"
T03-1010-2

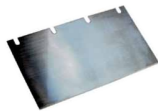

8 1/4" x 2 1/3"
T03-1010-3



Easy Floor Stripper™
T03-1000

- Removable handle extension for quick and efficient work
- Fast and clean removal of:
 - Carpet
 - Vinyl
 - Rubber
 - Hardwood Floors

Replacement Stripper Blades

9" Multi-Purpose Blade
T03-1000-1



5-3/8" Multi-Purpose Blade
T03-1000-2



Left Side Blade **T03-1000-3**
Right Side Blade **T03-1000-4**



4" Flooring Blade
T03-1000-5



17" Pro Floor Machine, 1.5 hp™
T03-2180



- 175 rpm
- 1.5 hp
- 100 lbs empty weight
- Solid chassis
- Metal gear box

16-17" Universal Dust Shroud
T03-2180-9



17" Roto Pro Disc™
T03-2186

15" Roto Pro Disc™
T03-2184

13" Roto Pro Disc™
T03-2185



Set of 6 Carbide Blades
w/ Screws & Nuts
T03-2184-1



Set of 3 Brackets
T03-2184-2



Plastic Universal Clutch Plate
T03-2180-1



Metal Universal Clutch Plate
T03-2180-2



16" Drive Disc
T03-2183



15" Diamond Disc
T03-2182



Replacement Diamond Disc
T03-2182-1



16" Brush Disc
T03-2181 (was 03-2185)

17" Brush Disc
T03-2191



16" Tungsten Carbide Split Disc
Double-Sided, 10 and 14 Grit
T03-2187-10
T03-2187-14



- T04-0606 6" Duckbill Napping Shears
- T04-0607 7" Duckbill Napping Shears
- T04-0608 8" Offset Napping Shears



- T04-0612 10" Carpet Shears
- T04-0613 12" Carpet Shears



- 501 Cushion Back Cutter
- T04-0501

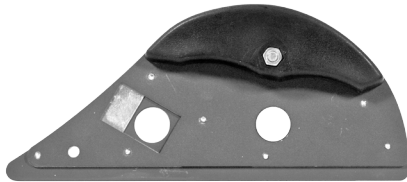

- Loop Pile Cutter
- T04-0505

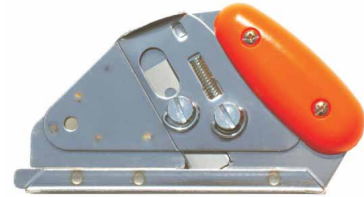

- Cushion Lock Cutter
- T04-0502



- Multi Purpose Wall Trimmer
- T04-0510

- Plastic Base Guard
- T04-0510-2



- Red Row Cutter
- T04-0499



Pro Aviation Snips
 T04-0629 Left
 T04-0630 Straight
 T04-0631 Right



Shoe Molding Mitre Cutter
 T04-0601



Repl. Mitre Cutter Blade
 T04-0601-1



Utility Knife
 T04-0410



Pro Utility Knife
 T04-AB105



Push Button Razor Knife
 T04-0430



Dolphin Knife
 T04-0420



Pro Cut 18mm Snap-Off Knife
 T04-AB112



Razor Knife
 T04-0440



Pro Cut Wheel Lock 18mm Snap-Off Knife
 T04-AB113



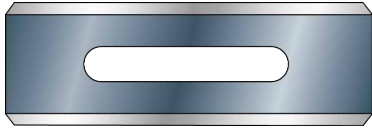

.017" HD Blue
Slotted Round Blade
T04-3017

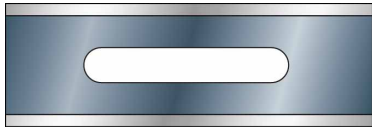

.017" HD Blue
Slotted Square Blade
T04-3023



.015" Regular
Slotted Round Blade
T04-3019



0.015" Regular
Slotted Square Blade
T04-3083

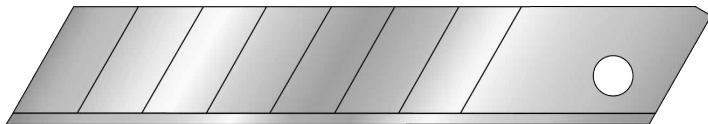

8 point HD Snap-Off Blade
T04-3050

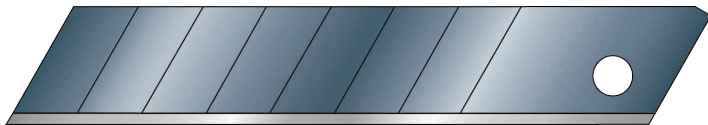

8 point Extreme Snap-Off Blade
T04-3055



- 30% Higher Carbon Steel
- 35-50% Longer Lasting
- Razor Sharp Edges
- Safety Dispensers

.025" HD Utility Blade
T04-3003

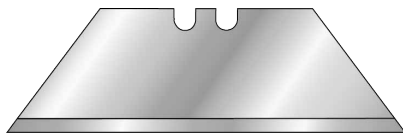

.025" HD Blue
3-Notch Blade
T04-3081

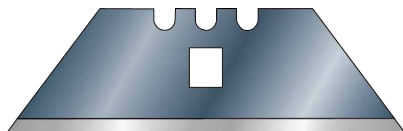

.017" Trimmer Blade
T04-3021

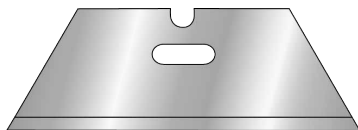

German Style
Utility Blade
T04-3100

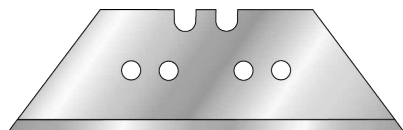

.025" HD Super
Hook Blade
T04-3105

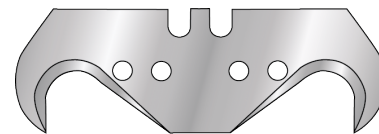

.025" German HD
Super Hook Blade
T04-3115

.025" HD Hook Blade
T04-3104

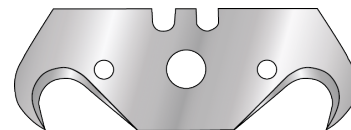

.025" German HD
Hook Blade
T04-3114

.025" HD Concave
Blade
T04-3106

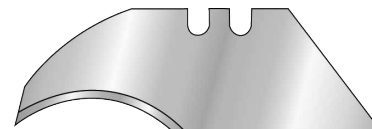

.025" German HD
Concave Blade
T04-3116

.020" 4" Scraper Blade
T04-3027



.036" 4" HD Scraper Blade
T04-3030



.036" 5" HD Scraper Blade
T04-3075



.036" 8" HD Scraper Blade
T04-3032



Pro Glide™ 3" Professional Seaming Iron 120V

T04-0330

- Even & steady heat disbursement
- Non stick grooved base plate
- Cool top design



Seaming Iron Carrying Case

T04-0310



Pro Glide™ 6" Heat Bond Iron 120V

T04-0336

- Even & steady heat disbursement
- Non stick grooved base plate
- Cool top design



6" Smooth Seam Roller

T04-0269



3" Seam Roller 11 stars

T04-0270



6" Seam Roller 19 stars

T04-0272

Pro Glide™ 3" Seaming Iron Kit

T04-0340



Carpet Tractor

T04-0278



Pro Stic™ Glue Gun

04-2200

- 380°F preset for optimal melting point
- 220 Watt, 120V
- Removable stand



Easy Stic™ Glue Gun

04-2100

- 380°F preset for optimal melting point
- 100 Watt, 120V
- ON/OFF switch



Pro Stic™ Hot Melt Glue Sticks

04-2212

- 18 Sticks
- 1 lb bag



High Arc Knee Kicker

04-0160



Deluxe Knee Kicker

04-0150



F1 Knee Kicker

04-0140



Nap Grip Inserts for Knee Kickers

04-0150-2



2" Bumper Pad for all Knee Kickers

04-0150-4



3" Bumper Pad for all Knee Kickers

04-0150-5



Pin Plate

04-0150-1

For 04-0150 & 04-0160



F1 Pin Plate

04-0140-1

For 04-0140

Seam Squeezers (pair)
T04-0220



Row Runner Set
T04-0490



3 1/2" Stair Tool
T04-0281



Carpet Awl
T04-0495



3 1/2" Bent Stair Tool
T04-0283



Turning Awl
T04-0487



T Handle Stair Tool
T04-0284



Tucker Roller
T04-0290

Replacement Set of
Wheels & Axles
T04-0290-1



Tucking/Lino Knife
T04-0475



24" Mini Stretcher Case
T12-0124



Mini Stretcher Replacement Pin Plate
T04-0170-1



Mini Stretcher with Ratchet Handle, Repair Head & Case
T04-0170
T04-0170-2
bulk, no case



T04-0170-4
Mini Stretcher Claw Attachment



Fixed Head Power Stretcher Set
T04-0190

Swivel Head Power Stretcher Set
T04-0200

Power Stretcher Wheeled Case
T04-0205



Power Stretcher Head (fixed)
T04-0190-1



Power Stretcher Head (swivel)
T04-0200-1



T04-0207 Stretcher Hook
T04-0207-1 Repl. Spike
T04-0207-2 Repl. Pin



Wall Piece with Rollers
T04-0200-2



3ft Stretcher Pole
T04-0201



3ft Auto Lock Tube
T04-0203

35 lb Linoleum Roller

T05-3035

75 lb Linoleum Roller

T05-3075

100 lb Linoleum Roller

T05-3100



J-Roller

T05-3010



Extendable Floor Roller

T05-3020

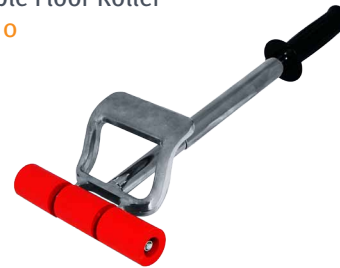

12" Pro VCT Cutter

T05-0912

Pair of 12" Repl. Blades

T05-0912-2

18" Pro VCT Cutter

T05-0918

Pair of 18" Repl. Blades

T05-0918-2



5mm Reduction Nozzle
T05-0200

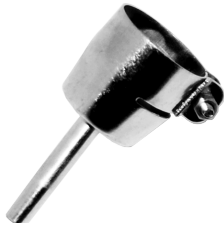

Hot Tip Tool
T05-2000



Cove Base Nozzle
(3 holes)
T05-0451



Cove Base Nozzle
(11 holes)
T05-0450



Triangle Speed Welding Tip
T05-0191



Inside Corner Spoon
T05-2000-1



Outside Corner Spoon
T05-2000-2

Topset Gouge
T05-0470



4mm Welding Tip
T05-0194



Brass Brush
T05-0280



Exacto Knife
T05-0090



5mm Speed Welding Tip
T05-0195



Caulking Gun 1/10 Gal
T05-0700

Caulking Gun 1/4 Gal
T05-0701



Diamond Blade
T05-0091-1
Set of 2 blades



Flat Round Blade
T05-0091-2
Set of 2 blades



Small Round Blade
T05-0091-3
Set of 2 blades



Large Round Blade
T05-0091-4
Set of 2 blades



Quarter Moon Knife
T05-0030



Groover
T05-0010



Groover Blades
05-0011
Set of 5 Blades



111A Style 6" Scriber
T05-0074



Recess Scriber
T05-0076



Set of 5 Replacement pins
for the Recess Scriber
T05-0076-1

Bar Scriber
T05-0078



Angled Quarter Moon Knife
T05-0031

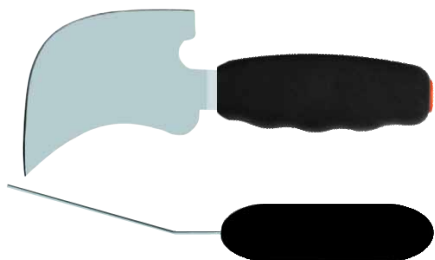

Feed Roller
T05-0037



Trim Guide
T05-0025



Multi Scriber
T05-0080



Set of 5 Pins and 5 Blades
for the Multi Scriber
T05-0081



Curved Quarter Moon Knife
T05-0032



Sharpening Stone
T05-0060



Reverse Scriber
T05-0082



Pro Heat Welding Kit™

T05-0110



Includes the following:

1. Pro Heat Welding Gun
2. Reduction Nozzle
3. 5mm Speed Welding Tip
4. 4mm Welding Tip
5. Triangle Welding Tip
6. Brass Brush
7. Quartermoon Knife
8. Trim Guide
9. Groover
10. Feed Roller
11. Scribe
12. Sharpening Stone
13. Professional Carrying Case

Pro Heat Welding Gun™

T05-2400



Heating Element

T05-2400-1



Pro Hot Knife™

T04-2600



Pro Engineered Cutter™

- Cuts:
- Engineered hardwood
 - Laminate
 - VCT
 - LVT tile & plank
 - Rubber
 - Carpet tile

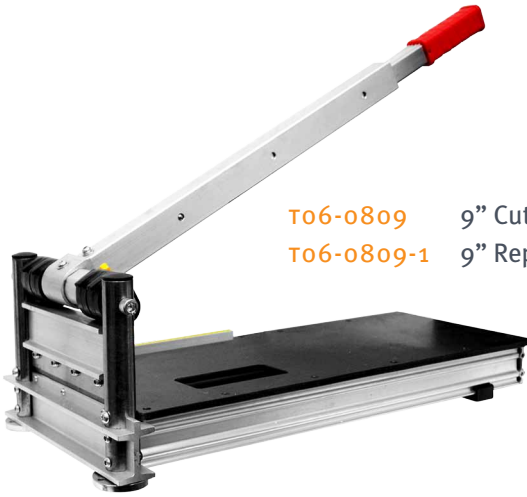

T06-0809 9" Cutter
T06-0809-1 9" Repl. Blade

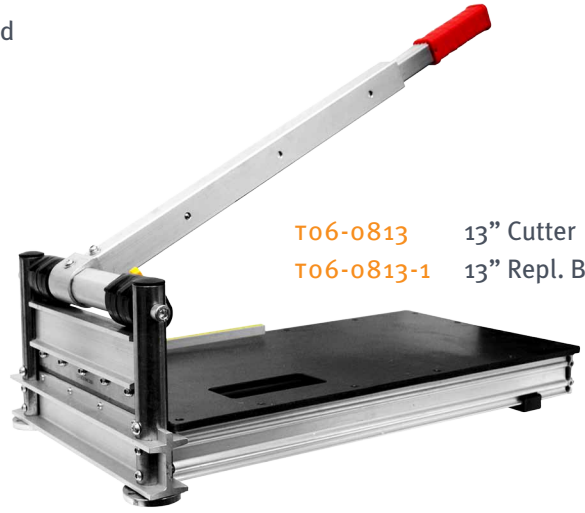

T06-0813 13" Cutter
T06-0813-1 13" Repl. Blade

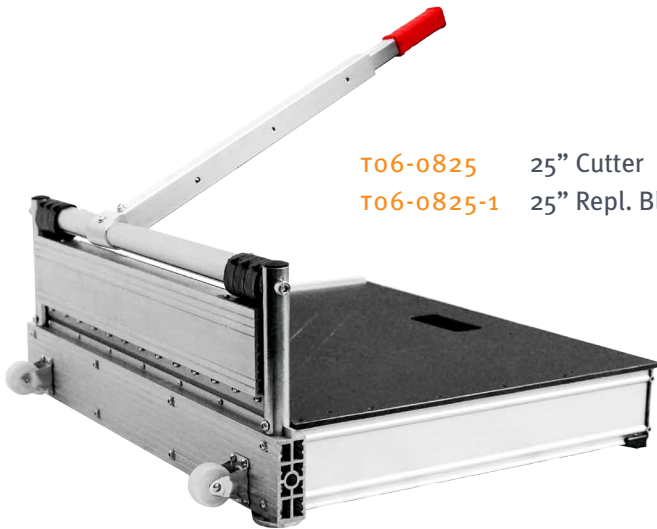

T06-0825 25" Cutter
T06-0825-1 25" Repl. Blade

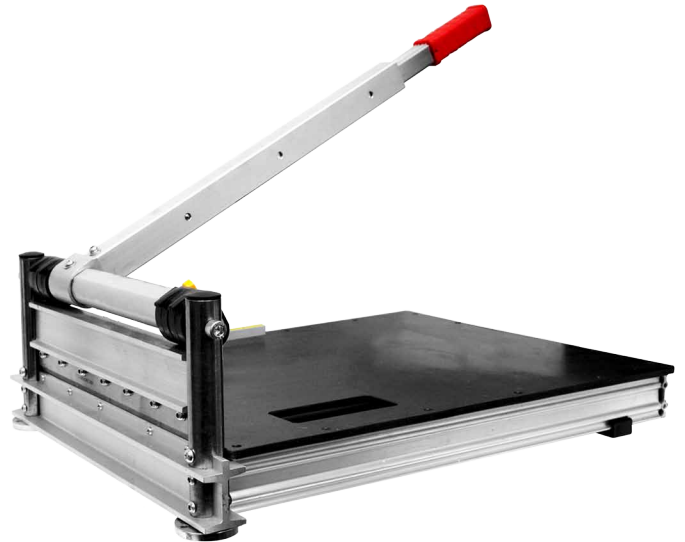

T06-0819 19" Cutter
T06-0819-1 19" Repl. Blade

Ratchet Strap Clamp
T06-0100



Adjustable Wall Spacer
T06-0150



22" Pro HD Pull Bar
T06-0121

Pull Bar Punch
T06-0121-1



Laminate Installation kit, 22 pieces
T06-0190



Hard Cap Knee Pads
T02-1017



Pro Wall Jack
T06-0130



24" Metal Tool Box incl. Seam Weight Attachment
T12-0124



Profile Template
T03-0120



Tapping Block w/Grooves

T06-0161 8"
T06-0162 16"



24" Klinker Cutter
T08-0223



Scoring Wheel
T08-0223-1



24" Ceramic Tile Cutter
T08-0224

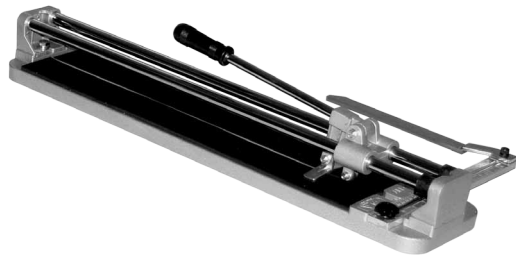

29" Klinker Tile Cutter
T08-0228

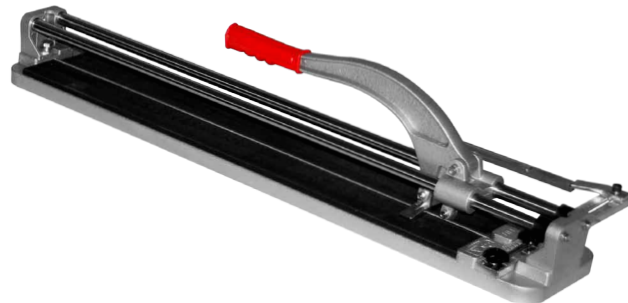

Multi-Speed Pro Mixer
T03-4000



Standard Mixer
T03-4010



Twist Mixer
T03-4020



Double Suction Cup
T08-0102



4 5/8" Suction Cup
T08-0101



8" Pro Suction Cup
T08-0103



ONE YEAR LIMITED MANUFACTURER'S WARRANTY

One-Year Manufacturer's Warranty

All Tego Systems products have been designed and manufactured to ensure your full satisfaction. If for any reason you are not satisfied, please let us know so we can try to rectify the situation.

The Tego Systems guarantee is that our products will be free of defects during your first year of ownership, and if there is a manufacturing defect we will repair or replace the product. This warranty does not cover abuse or normal wear and tear.

In the event of a suspected defect contact the distributor where you purchased the product to see if it qualifies for repair or replacement.



CONCRETE NAIL

- T10-1000-10 1" Concrete Nail 10 GA
- T10-0750-10 3/4" Concrete Nail 10 GA
- T10-0687-12 11/16" Concrete Nail 12 GA
- T10-0625-10 5/8" Concrete Nail 10 GA
- T10-0500-10 1/2" Concrete Nail 10 GA

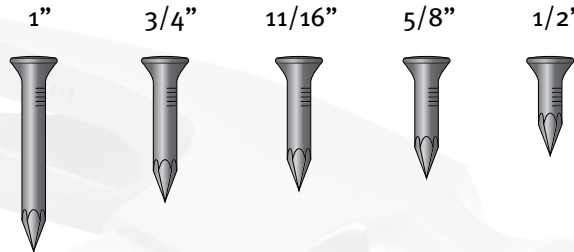

1 LB/BAG
12 BAGS/CASE

ELASTICEL NAIL

- T10-1250-EL 1 1/4" Elasticel Nail

1 LB/BAG
10 BAGS/CASE

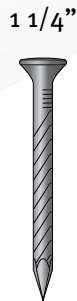

- High Carbon Steel
- Max Grip Strength
- Easy Dispensing Pack

PLASTERBOARD NAIL

- T10-1250-PL 1 1/4" Plasterboard Nail

1 LB/BAG
10 BAGS/CASE



White Rubber Mallet, 20 oz
T04-0676



Nail Driver Bar
T04-0670



Ripping Hammer, 23 oz
T04-0678



Magnetic Nail Holder
T04-0671 5 1/2" long
T04-0672 8" long

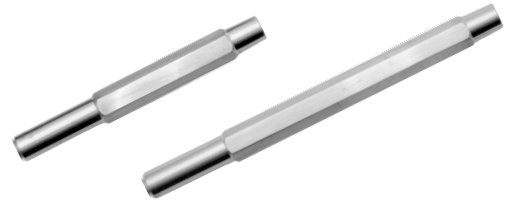

Base Molding Lifter
T04-0680



Tackless Half Hatchet
& Hammer, 25 oz
T04-0679



Pro Bar
T04-0690 15"



Pro Flooring Stapler™
T07-M3FS

- Fastener Range: 15 GA Staples
- Length: 1-1/2" - 2"
- Crown: 1/2"
- Operating Pressure: 80 - 100 PSI



1800 Series Pro Stapler™
T07-0184

- Fastener Range: 18 GA Staples
- Length: 3/4" - 1-1/2"
- Crown: 1/4"
- Operating Pressure: 70-100 PSI
- For Underlayment



Pro Flooring Cleat Nailer™
T07-M3FN

- Fastener Range: 16 GA Cleat Nails
- Length: 1-1/2" - 2"
- Operating Pressure: 80 - 100 PSI
- Takes T & L Cleats



18 GA Pro Flooring Stapler™
T07-0185

- Fastener Range: 18 GA Staples
- Length: 3/4" - 1-1/2"
- Crown: 1/4"
- Operating Pressure: 70 - 100 PSI
- For Engineered Hardwood



A11 Pro Hammer Tacker™
T07-0711



550 Pro Hammer Tacker™
T07-0550



755 Pro Hammer Tacker™
T07-0755



Pad Staples

T07-0A11C
T07-0A11D



5000/box
20 boxes/case

T07-7512D

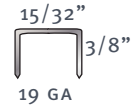

5000/box
20 boxes/case

T07-5010C
T07-5010D

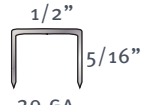

Carpet Staples

T07-5418C
T07-5418D



5000/box
20 boxes/case

GOLD STANDARD STAPLES

- High Carbon Steel
- Optimal Tensile Strength
- Divergent or Chisel Point as needed per Application
- Heavy Duty Tackers

Underlayment Staples, Chisel Point

T07-1828C T07-1832C T07-1836C T07-1840C T07-1848C



5000/box
8 box/ctn

Hardwood Staples, Chisel Point

T07-1515C T07-1517C T07-1520C



5000/box
1 box/ctn

Products Ending in C: Chisel Point
Products Ending in D: Divergent Point

PRO TRAC & ADVANCED WHITE FORMULA SEAMING TAPE

- Quick Strong Grab
- No Smoke
- Low Odor



PRO TRAC™

T15-0110	3" Easy Trac 10
T15-0120	3" Pro Trac 20
T15-0130	4" Pro Trac X30
T15-0140	3" Pro Trac 40
T15-0150	4" Pro Trac X50
T15-0160	6" Pro Trac 60

66 Feet/Roll

ADVANCED WHITE FORMULA™

T15-0020	3" Advanced White 20
T15-0030	4" Advanced White X30
T15-0040	3" Advanced White 40
T15-0050	4" Advanced White X50
T15-0060	6" Advanced White 60

GOLD STANDARD™

T15-0140-G	3" GS3 Gold Foil Tape
------------	-----------------------



HEAVY DUTY SILICONE CARBIDE ABRASIVES

7" Sanding Disc

T09-1007-12 12 Grit
T09-1007-20 20 Grit

16" Sanding Disc

T09-1016-12 12 Grit
T09-1016-16 16 Grit
T09-1016-20 20 Grit
T09-1016-36 36 Grit
T09-1016-60 60 Grit
T09-1016-80 80 Grit
T09-1016-100 100 Grit

17" Sanding Disc

T09-1017-12 12 Grit
T09-1017-16 16 Grit
T09-1017-20 20 Grit
T09-1017-36 36 Grit
T09-1017-60 60 Grit
T09-1017-80 80 Grit
T09-1017-100 100 Grit

20" Sanding Disc

T09-1020-12 12 Grit
T09-1020-16 16 Grit
T09-1020-20 20 Grit
T09-1020-36 36 Grit
T09-1020-60 60 Grit
T09-1020-80 80 Grit
T09-1020-100 100 Grit

16" Sanding Screen

T09-2016-60 60 Grit
T09-2016-80 80 Grit
T09-2016-100 100 Grit

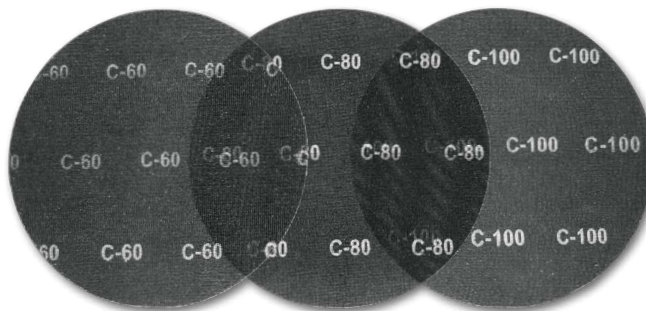

17" Sanding Screen

T09-2017-60 60 Grit
T09-2017-80 80 Grit
T09-2017-100 100 Grit

Kraft Floor Protector

T11-1144 35X144

T11-1300 35X300



Carpet Protector Film

T11-9424 24X200

T11-9436 36X200

- Non tearing
- Rollable
- Self sticking



Easy Floor Board™

T11-2100 38X100

Pro Floor Board™

T11-2101 38X100





Pro Flat Back Tape™
T11-3301 2"x180'



Filament Tape
T11-50075 0.75"x180'
T11-5010 1"x180'



Pro Blue Masking Tape™
(14 days UV Resistant)
T11-3101 2"x180'



Easy Masking Tape™
T11-3001 2"x180'



Pro Duct Tape™
T11-3208 2"x180'



Pro Double Stick Tape™
T11-4010 1"x165'
T11-4015 1.5"x165'
T11-4035 3.5"x165'
T11-4060 6"x165'
T11-4090 9"x165'
T11-4095 9.5"x165'



FLOOR DOT[®]
install with pride!

TEGO SYSTEMS CORP
1650 HORIZON PKWY, SUITE 200
BUFORD, GA 30518
USA

PHONE: +1 (404) 592 1230
FAX: +1 (404) 592 1233
WWW.TEGOSYSTEMS.COM