



PROVA® by  **PRO**
Tile Installation Products



Tile Installation Products

A NEW PERSPECTIVE ON TILE INSTALLATION PRODUCTS

PROVA® Tile Installation Products by M-D PRO® offers a broad assortment of quality products with innovative features that provide simplified and flexible installation options to all who use them. For over 15 years, the PROVA® product line has been providing professionals and consumers with a reliable alternative they can count on. With our customer-centric approach and direct relationships with the professional installation segment, the PROVA® selection is intended to cover the most common applications we see in the marketplace today. Our comprehensive line includes:

- ❖ **Modular shower systems** – pans, extensions, and components designed to work together, providing choice and flexibility in creating any shower base design desired!
- ❖ **Waterproofing systems** – waterproofing membrane and accessories that are ICC-ES certified and approved for use in intermittent-use steam showers. Waterproofing tile backer board that is can be used in a variety of ways for building and substrate purposes. It provides superior strength, rigidity, as well as thermal resistance to help with reduction of thermal transfer and impact sounds.
- ❖ **Drain systems** – with patented mortar adhesion technology guaranteeing a waterproof and reliable bond between the drain and shower pan
- ❖ **Tile underlayment systems** – with lightweight functionality, "Extra Heavy" ratings, superior strength, and workability
- ❖ **Tile trims, nosing and multi-purpose profiles** – available in anodized aluminum, stainless steel, and PVC in today's most popular finishes. Offerings available for both commercial and residential projects.

At M-D PRO®, we pride ourselves on our personal, customer-first approach to business and our proactive service reputation. We also take this approach with product innovation. PROVA® Tile Installation Products are designed, engineered, and developed in North America and with our North American end users in mind. We ensure that all products meet North American flooring and building standards and we are committed to innovation that continues to simplify installation processes for our users and provide product selection value to our customers.

For any questions or technical support pertaining to PROVA® Tile Installation Products, please contact our customer service department. Our team of specialists will be happy to assist you. Also, be sure to follow us on social media for installation tips and to stay up to date on new PROVA® product innovations!



M-D PRO® a division of a 100-year-old business, M-D® Building Products, provides the broadest range of Floor Covering & Building Accessories in the industry! Our core business is a traditional line of aluminum and vinyl extruded floor transitional moldings that aid in a spectrum of installation challenges. M-D PRO® has remained committed to providing customers and end user with innovative product lines that include PROVA® Tile Installation Products, M-D Tools, TOWER Sealants. These growing product lines continue to complement M-D PRO® Flooring Accessories, our core line of trims for carpet, ceramic, laminate, vinyl, resilient and hardwood floors.

Technical Service Hotline: 1-888-MDPROVA (1-888-637-7682)

1 800 565 6653 | service@mdteam.com | www.provaproducts.com |    @mdproproducts

TABLE OF CONTENTS

SHOWER SYSTEMS & COMPONENTS

PROVA-SHOWER SYSTEM® & COMPONENTS

PROVA-SHOWER SYSTEM®06
 PROVA PAN®08
 PROVA UNIVERSAL EXTENSION KIT®08
 PROVA CURB®09
 PROVA DRAIN®10
 PROVA DRAIN GRATE®11

PROVA PAN-MULTI®

PROVA PAN-MULTI®13
 PROVA PAN-MULTI EXTENSION KIT®13

PROVA LINEAR SYSTEM® & COMPONENTS

PROVA LINEAR SYSTEM®15
 PROVA LINEAR DRAIN®16
 PROVA LINEAR DRAIN® GRATE16
 PROVA LINEAR PAN®16
 PROVA LINEAR PAN EXTENSION®17
 PROVA LINEAR PAN KIT® - CENTER DRAIN...17
 PROVA LINEAR PAN KIT® - END DRAIN17

PROVA® TILE EDGE

ALUMINUM TILE EDGE

FLAT TILE EDGE32
 ROUND TILE EDGE34
 ROUND OUTSIDE CORNER35
 ROUND INSIDE CORNER35
 SQUARE TILE EDGE36
 SQUARE CORNER36
 CERAMIC COVE37
 CERAMIC COVE CORNER37
 J-MOLDING38
 CERAMIC ADAPTER39
 CERAMIC REDUCER40
 CERAMIC TILE STAIR NOSING41
 DECORATIVE TILE STAIR NOSING42
 DUAL-PURPOSE DECORATIVE EDGING42

WATERPROOFING

PROVA-MAT®

WATERPROOFING MEMBRANE

PROVA-MAT®20
 PROVA JOINT®20
 PROVA CORNER®21
 PROVA PIPE SEAL®21

PROVA BOARD®
PLUS+

WATERPROOFING TILE BACKER & ACCESSORIES

PROVA BOARD® PLUS22
 PROVA BOARD PAN ASSEMBLY KIT®23
 PROVA NICHE®24
 PROVA NICHE GLASS SHELF®24
 PROVA-SEAL™25
 PROVA FASTENERS®25

TILE UNDERLAYMENT SYSTEMS

PROVA FLEX-HEAT®28
 PROVA-FLEX®29
 PROTEGGA PLUS®29

PVC TILE EDGE

VINYL TILE EDGE50
 VINYL J CAP51
 EXPANSION JOINT51
 HEAVY DUTY VINYL EDGE - FLAT52
 HEAVY DUTY VINYL EDGE - ROUND52
 HEAVY DUTY VINYL EDGE -
 ROUND CORNERS53

FINISHES/WARRANTY/INDEX

.....54





PROVA[®]

SHOWER SYSTEMS & COMPONENTS

PROVA[®] offers a complete line of modular shower systems and components designed to work together to produce watertight, failure-free shower assemblies! When used collectively, PROVA[®] pans, extensions, and drains offer an easy, efficient way to install a shower base that will always have an even slope and can be customized to meet the size and shape of your choosing. All offerings provide protection against water and vapor penetration and are resistant to mold and mildew buildup over years of use. Step into an unfinished bathroom with PROVA[®] products and discover how the components come together to simplify the installation process!



PROVA-SHOWER SYSTEM®

PROVA-SHOWER SYSTEM®

Pack Size: 1 Kit

A complete, easy-to-install waterproofing system for maintenance-free tiled showers

- Contains all the components required to build a fully bonded, water-tight shower assembly
- Protects wall cavities against water and vapor penetration
- Modular sloped pan system provides flexibility in installation and replaces the need for a mortar base
- PROVA-MAT® waterproofing membrane is certified by ICC-ES and can be used in steam showers when installed over PROVA-BOARD PLUS®

CAN 🇨🇦

GRATE FINISH/PART NO.

TOTAL PAN SIZE	DRAIN PLACEMENT/MATERIAL	Stainless Steel (STS)	Chrome (CRM)	Brass (BRS)	Bronze (BRZ)	Graphite (GRH)
48" x 48" (122 cm x 122 cm)	Center/ABS	TT8206STS05	TT8206CRM05	TT8206BRS05	TT8206BRZ05	TT8206GRH05
32" x 60" (81 cm x 152 cm)	Offset/ABS	TT8209STS05	TT8209CRM05	TT8209BRS05	TT8209BRZ05	TT8209GRH05
32" x 60" (81 cm x 152 cm)	Center/ABS	TT8409STS05	TT8409CRM05	TT8409BRS05	TT8409BRZ05	TT8409GRH05
48" x 48" (122 cm x 122 cm)	Center/PVC	TT8306STS05	TT8306CRM05	TT8306BRS05	TT8306BRZ05	TT8306GRH05
32" x 60" (81 cm x 152 cm)	Offset/PVC	TT8309STS05	TT8309CRM05	TT8309BRS05	TT8309BRZ05	TT8309GRH05
32" x 60" (81 cm x 152 cm)	Center/PVC	TT8509STS05	TT8509CRM05	TT8509BRS05	TT8509BRZ05	TT8509GRH05

U.S 🇺🇸

GRATE FINISH/PART NO.

TOTAL PAN SIZE	DRAIN PLACEMENT/MATERIAL	Stainless Steel (STS)	Chrome (CRM)	Brass (BRS)	Bronze (BRZ)	Graphite (GRH)
48" x 48" (122 cm x 122 cm)	Center/ABS	TT8206STS05ES	TT8206CRM05ES	TT8206BRS05ES	TT8206BRZ05ES	TT8206GRH05ES
32" x 60" (81 cm x 152 cm)	Offset/ABS	TT8209STS05ES	TT8209CRM05ES	TT8209BRS05ES	TT8209BRZ05SE	TT8209GRH05SE
32" x 60" (81 cm x 152 cm)	Center/ABS	TT8409STS05ES	TT8409CRM05ES	TT8409BRS05ES	TT8409BRZ05ES	TT8409GRH05ES
48" x 48" (122 cm x 122 cm)	Center/PVC	TT8306STS05ES	TT8306CRM05ES	TT8306BRS05ES	TT8306BRZ05ES	TT8306GRH05ES
32" x 60" (81 cm x 152 cm)	Offset/PVC	TT8309STS05ES	TT8309CRM05ES	TT8309BRS05ES	TT8309BRZ05ES	TT8309GRH05ES
32" x 60" (81 cm x 152 cm)	Center/PVC	TT8509STS05ES	TT8509CRM05ES	TT8509BRS05ES	TT8509BRZ05ES	TT8509GRH05ES

Note: PROVA® products are to be installed using premium polymer-modified thinset mortar only. Premixed mortar or mastic are not to be used. Installations completed with polymer-modified thinset mortar that meets the most current version of the ANSI A118.15 standard may qualify for a limited lifetime warranty. Refer to the warranty summary page on page 55, installation instructions and technical data sheets for complete product information & appropriate application conditions.

PROVA-SHOWER SYSTEM®

PROVA-SHOWER SYSTEM®

Pack Size: 1 Kit

EACH PROVA-SHOWER® KIT INCLUDES:

LABELS	DESCRIPTIONS	SPECS	QTY
A	PROVA PAN®	48" x 48" (122 cm x 122 cm) center drain placement or 32" x 60" (81 cm x 152 cm) center drain placement or 32" x 60" (81 cm x 152 cm) offset drain placement	1 pc
B	PROVA-MAT PAN LINER®	48" x 48" (122 cm x 122 cm) or 32" x 60" (81 cm x 152 cm)	1 pc
C	PROVA-MAT®	135 sq. ft. (12.5 sq. m) - 48" x 48" (122 cm x 122 cm) shower kit 108 sq. ft. (10 sq. m) - 32" x 60" (81 cm x 152 cm) shower kits	1 roll - 48" x 48" shower kit 1 roll - 32" x 60" shower kits
D	PROVA DRAIN® (Stainless steel grate included)	ABS or PVC	1 pc
E	PROVA CORNER®	4-1/2" x 2-1/4" x 3-1/2" (11.43 cm x 5.72 cm x 8.89 cm)	4 pcs - inside corners 2 pcs - outside corners
F	PROVA JOINT®	41" x 5" (12.5 m x 12.7 cm)	1 pc
G	PROVA PIPE SEAL®	4-3/4" x 4-3/4" (12.07 cm x 12.07 cm) Diameter for pipe opening: 7/16" (1.11 cm)	1 pc
H	PROVA CURB®	4-1/2" x 4" x 48" (11 cm x 10 cm x 122 cm)	2 pcs in 32" x 60" (81 cm x 152 cm) shower kits 1 pc in 48" x 48" (122 cm x 122 cm) shower kit



48" x 48" Kit (Center/ABS)



32" x 60" Kit (Offset/ABS Drain)



32" x 60" Kit (Center/PVC Drain)

Note: PROVA® products are to be installed using premium polymer-modified thinset mortar only. Premixed mortar or mastic are not to be used. Installations completed with polymer-modified thinset mortar that meets the most current version of the ANSI A118.15 standard may qualify for a limited lifetime warranty. Refer to the warranty summary page on page 55, installation instructions and technical data sheets for complete product information & appropriate application conditions.



PROVA PAN®

PROVA PAN®

Pack Size: 1 pc

PROVA PAN® is a prefabricated, modular sloped pan that is perforated into sections to provide installation flexibility. The pan replaces the need for a mortar base and can be cut down as needed.

PROVA-MAT PAN LINER® included, PROVA DRAIN® sold separately.

PART NO.	TOTAL PAN SIZE	THICKNESS	DRAIN PLACEMENT	MATERIAL
TT8008PAN04	48" x 48" (122 cm x 122 cm)	1-5/8" (4.1 cm)	Center	Expanded polystyrene
TT8013PAN02	32" x 60" (81 cm x 152 cm)	1-5/8" (4.1 cm)	Offset, 10" O.C.	Expanded polystyrene
TT8113PAN02	32" x 60" (81 cm x 152 cm)	1-5/8" (4.1 cm)	Center	Expanded polystyrene

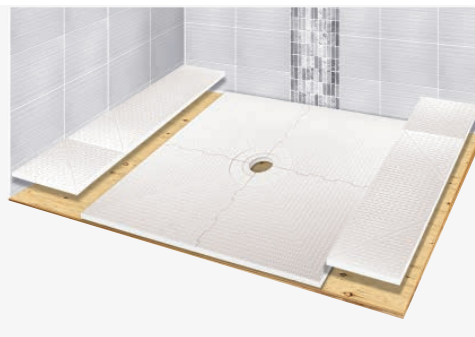

PROVA UNIVERSAL EXTENSION KIT®

PROVA UNIVERSAL EXTENSION KIT®

Pack Size: 4 pcs/box

PROVA UNIVERSAL EXTENSION KIT® can be used to extend a PROVA PAN® base to any desired size. Perforated corner edges are easy to cut and allow for flexibility in shower base layouts. Design possibilities are endless when using multiple extension kits!

PART NO.	SIZE PER EXTENSION	THICKNESS	MATERIAL
TT8011EXT04	12" x 36" (30 cm x 91 cm)	1-5/8" (4.1 cm)	Expanded polystyrene



Note: PROVA® products are to be installed using premium polymer-modified thinset mortar only. Premixed mortar or mastic are not to be used. Installations completed with polymer-modified thinset mortar that meets the most current version of the ANSI A118.15 standard may qualify for a limited lifetime warranty. Refer to the warranty summary page on page 55, installation instructions and technical data sheets for complete product information & appropriate application conditions.

PROVA CURB®

PROVA CURB®

Pack Size: 1 pc

PROVA CURB® is a low-profile prefabricated shower curb that can be installed with any shower base. It can be easily waterproofed using PROVA-MAT® waterproofing membrane, and it features a dovetail recess for better mortar adhesion.

PART NO.	SIZE (W x H x L)	MATERIAL
TT8015CRB48	4-1/2" x 4" x 48" (11 cm x 10 cm x 122 cm)	Expanded polystyrene
TT8012CRB60	4-1/2" x 4" x 60" (11 cm x 10 cm x 152 cm)	Expanded polystyrene

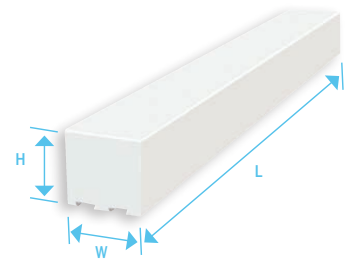

Note: PROVA® products are to be installed using premium polymer-modified thinset mortar only. Premixed mortar or mastic are not to be used. Installations completed with polymer-modified thinset mortar that meets the most current version of the ANSI A118.15 standard may qualify for a limited lifetime warranty. Refer to the warranty summary page on page 55, installation instructions and technical data sheets for complete product information & appropriate application conditions.



PROVA-BOND™
Surface Treatment

Waterproof mortar adhesion technology
Featured only with PROVA DRAIN®

PROVA DRAIN®

PROVA DRAIN®

Pack Size: 1 pc

PROVA DRAIN® is an easy-to-install drain system that can be used with PROVA PAN®, PROVA PAN-MULTI®, and mortar bases. The drain is coated with PROVA-BOND™ surface treatment technology, which provides a waterproof, strong, and reliable bond between the drain flange, mortar, and shower pan. Each drain includes a 304 stainless steel drain grate, along with a grate housing that includes a height-adjustment collar and ring for adapting to multiple tile thicknesses.



GRATE FINISH/PART NO.	DRAIN MATERIAL	GRATE FINISH/PART NO.	DRAIN MATERIAL
Stainless Steel (STS)	ABS	Stainless Steel (STS)	PVC
TT8007STS03		TT8107STS03	

PROVA DRAIN® is also available without the stainless steel drain grate inclusion. Compatible PROVA DRAIN GRATE®'s in 5 designer finishes are sold separately and allow for customization flexibility. See page 11 for more details.

DRAIN MATERIAL		DRAIN MATERIAL	
PART NO.	ABS	PART NO.	PVC
TT8007NOG03		TT8107NOG03	

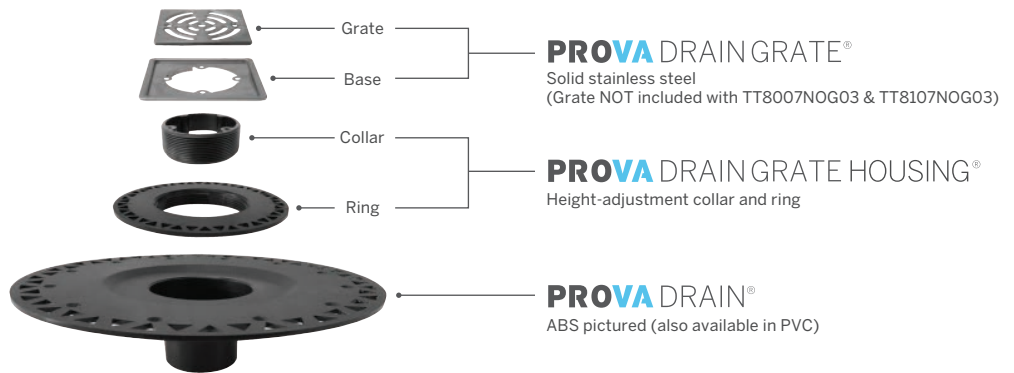

Note: PROVA® products are to be installed using premium polymer-modified thinset mortar only. Premixed mortar or mastic are not to be used. Installations completed with polymer-modified thinset mortar that meets the most current version of the ANSI A118.15 standard may qualify for a limited lifetime warranty. Refer to the warranty summary page on page 55, installation instructions and technical data sheets for complete product information & appropriate application conditions.

PROVA DRAIN GRATE®







PROVA DRAIN GRATE® Pack Size: 8 pcs/ctn

PROVA DRAIN GRATE® is a 304 stainless steel drain grate designed for use with PROVA DRAIN®. The 4" x 4" (10.2 cm x 10.2 cm) grate is available in six designer finishes to complement today's most popular bathroom hardware fixtures.

***PROVA DRAIN® sold separately.**



GRATE FINISH/PART NO.

Stainless Steel (STS)	Chrome (CRM)	Brass (BRS)
 TT8204STS04	 TT8204CRM04	 TT8204BRS04
Bronze (BRZ)	Graphite (GRH)	Black (BLK)
 TT8204BRZ04	 TT8204GRH04	 TT8204BLK04



Note: PROVA® products are to be installed using premium polymer-modified thinset mortar only. Premixed mortar or mastic are not to be used. Installations completed with polymer-modified thinset mortar that meets the most current version of the ANSI A118.15 standard may qualify for a limited lifetime warranty. Refer to the warranty summary page on page 55, installation instructions and technical data sheets for complete product information & appropriate application conditions.



PROVA PAN-MULTI®

PROVA PAN-MULTI EXTENSION KIT®

PROVA PAN-MULTI®

PROVA PAN-MULTI®

Pack Size: 1 pc

PROVA PAN-MULTI® is a one-pan solution for curbed or curbless shower installations. Choosing a curbless application is ideal for accessible showers and open-concept aesthetics. The prefabricated sloped pan replaces the need for a mortar base, and its perforated sections make it easy to install.

***PROVA-MAT PAN LINER® included, PROVA DRAIN® sold separately.**

PART NO.	TOTAL PAN SIZE	THICKNESS	DRAIN PLACEMENT	MATERIAL
TT8114PAN05	60" x 60" (152 cm x 152 cm)	7/8" (2.2 cm)	Center	Expanded polystyrene

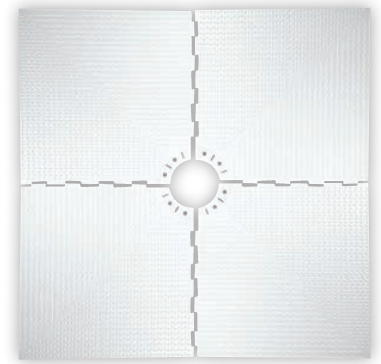

PROVA PAN-MULTI EXTENSION KIT®

PROVA PAN-MULTI EXTENSION KIT®

Pack Size: 8 pcs/box

PROVA PAN-MULTI EXTENSION KIT® is designed to be installed with PROVA PAN-MULTI® to create large square or rectangular shower bases. One kit can extend a shower base up to 84" x 84" (213 cm x 213 cm) or any size in between. Use multiple kits to achieve your shower design of choice!

***PROVA PAN-MULTI sold separately.**

PART NO.	SIZE PER EXTENSION	THICKNESS	MATERIAL
TT8115EXT04	48" x 12" (122 cm x 30 cm)	1/8" (3.2 mm) to 3/8" (9.5 mm)	Expanded polystyrene

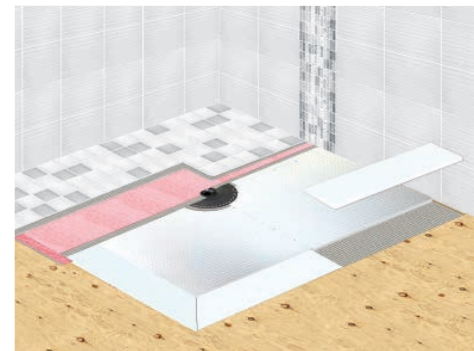

Note: PROVA® products are to be installed using premium polymer-modified thinset mortar only. Premixed mortar or mastic are not to be used. Installations completed with polymer-modified thinset mortar that meets the most current version of the ANSI A118.15 standard may qualify for a limited lifetime warranty. Refer to the warranty summary page on page 55, installation instructions and technical data sheets for complete product information & appropriate application conditions.



PROVA LINEAR DRAIN®

PROVA-MAT®

PROVA LINEAR PAN®

PROVA LINEAR PAN EXTENSION®

PROVA LINEAR®

PROVA LINEAR®

The PROVA LINEAR® system for tiled showers features a unique modular pan and extension structure that allows for complete versatility when building out any desired shower base size and drain placements. The system can be used with either PROVA BOARD® PLUS tile backer or PROVA-MAT® membrane to waterproof shower walls.

A	PROVA LINEAR PAN®		B	PROVA LINEAR PAN EXTENSION®	
C	Side Supports		D	Filler Strips (for End Drain flange support)	
E	TILE-IN-TOP (Tiling guide included. Tiles not included.)		F	Hair Catcher	
G	Drain Body with pre-bonded PROVA-MAT® membrane		H	PROVA-MAT® (sold separately)	
			Stainless Steel Grate (sold separately)		

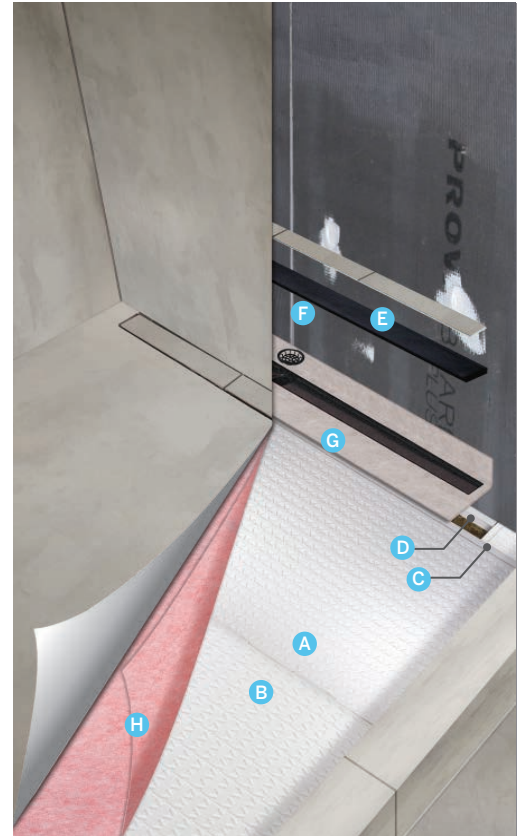

DESIGN POSSIBILITIES ARE ENDLESS WITH THE PROVA LINEAR® MODULAR PAN & EXTENSION SYSTEM:

END DRAIN - 4' X 4' (122 cm x 122 cm)

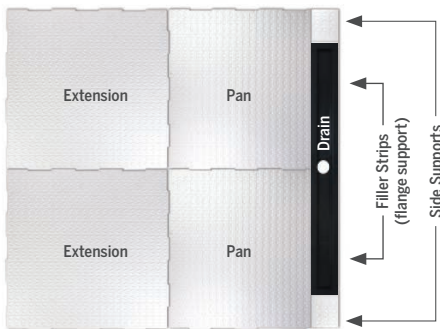

END DRAIN WITH PROVA LINEAR PAN EXTENSION® KIT - 4' X 6' (122 cm x 183 cm)

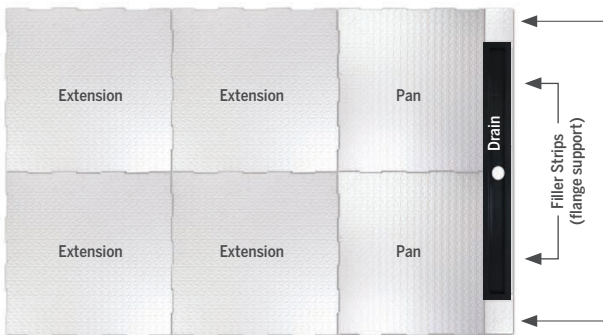

CENTER DRAIN - 4' X 4' (122 cm x 122 cm)

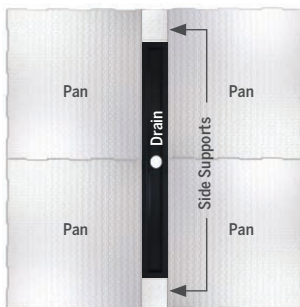

CENTER DRAIN WITH PROVA LINEAR PAN EXTENSION® KIT - 4' X 8' (122 cm x 244 cm)

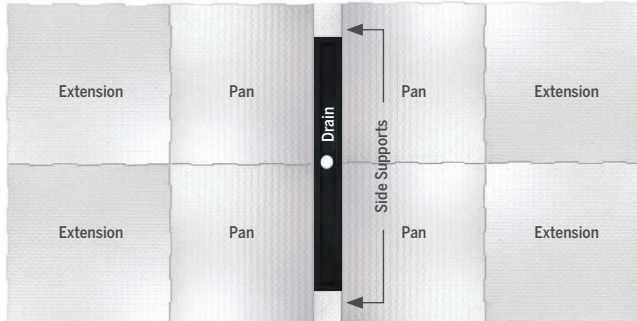

AND MANY MORE!

Note: PROVA® products are to be installed using premium polymer-modified thinset mortar only. Premixed mortar or mastic are not to be used. Installations completed with polymer-modified thinset mortar that meets the most current version of the ANSI A118.15 standard may qualify for a limited lifetime warranty. Refer to the warranty summary page on page 55, installation instructions and technical data sheets for complete product information & appropriate application conditions.



*Tiles shown in tile-in-top inclusion are not included

PROVA LINEAR DRAIN®

PROVA LINEAR DRAIN®

Pack Size: 1 kit

The PROVA LINEAR DRAIN® is available in three popular sizes. The drain body is coated with PROVA-BOND™ surface treatment technology for ultimate mortar adhesion. Pre-bonded PROVA-MAT® membrane is included on the drain flange, providing quick and easy waterproofing. The tile-in-top inclusion provides the aesthetic of a fully tiled shower floor without disrupting drainage. Hair catcher and tiling guide also included.



PART NO.	SIZE	ROUGH-IN SIZE	DRAIN MATERIAL
TT8900TNT24	24" (61 cm)	26" (66 cm)	ABS
TT8900TNT36	36" (91 cm)	38" (97 cm)	ABS
TT8900TNT42	42" (107 cm)	44" (112 cm)	ABS



PROVA LINEAR DRAIN GRATE®

PROVA LINEAR DRAIN® GRATE

Pack Size: 1 pc

The PROVA LINEAR DRAIN® GRATE is a durable, rust-resistant, and stylish 304 stainless steel grate option for any tiled shower. It can be used to replace the tile-in-top inclusion of the PROVA LINEAR DRAIN® kit. Includes drain grate and height adapting clips.

PART NO.	SIZE	MATERIAL
TT8910STS24	24" (61 cm)	304 Stainless steel
TT8910STS36	36" (91 cm)	304 Stainless steel
TT8910STS42	42" (107 cm)	304 Stainless steel



PROVA LINEAR PAN®

PROVA LINEAR PAN®

Pack Size: 1 kit

PROVA LINEAR PAN® is a pre-sloped, waterproof pan that can be used to build a linear shower base. Prefabricated sloped pan replaces the need for a mortar base. Includes 2 pieces of PROVA LINEAR PAN®, 2 side supports, and 2 filler strips.

PART NO.	SIZE PER PAN	THICKNESS	MATERIAL
TT8901PAN02	22.5" x 24" (57 cm x 61 cm)	1-5/8" (4.1 cm)	Expanded polystyrene

Note: PROVA® products are to be installed using premium polymer-modified thinset mortar only. Premixed mortar or mastic are not to be used. Installations completed with polymer-modified thinset mortar that meets the most current version of the ANSI A118.15 standard may qualify for a limited lifetime warranty. Refer to the warranty summary page on page 55, installation instructions and technical data sheets for complete product information & appropriate application conditions.

PROVA LINEAR PAN EXTENSION®

PROVA LINEAR PAN EXTENSION®

Pack Size: 1 kit

PROVA LINEAR PAN EXTENSION® is a pre-sloped, waterproof pan that can be used to extend the size of a linear shower base by adding them to existing linear pan pieces. Includes 2 pieces of PROVA LINEAR PAN EXTENSION®.



PART NO.	SIZE PER EXTENSION	THICKNESS	MATERIAL
TT8902EXT02	24" x 24" (61 cm x 61 cm)	1-5/8" to 2-1/8" (4.1 cm to 5.4 cm)	Expanded polystyrene

PROVA LINEAR PAN KIT® - CENTER DRAIN

PROVA LINEAR PAN KIT® - CENTER DRAIN

Pack Size: 1 kit

The PROVA LINEAR PAN KIT® for **center drain applications** features a unique modular pan system that is easy to install with its pre-sloped base and perforated edges. Kit includes 4 pieces of PROVA LINEAR PAN® and 2 side supports which can build up to a 48" x 48" linear shower base.

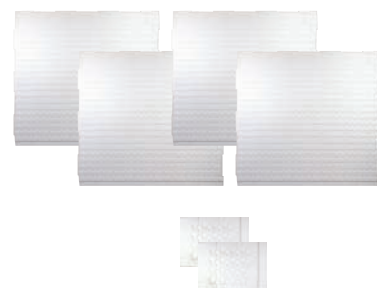

PART NO.	TOTAL PAN SIZE	THICKNESS	MATERIAL
TT8903CTR04	48" x 48" (122 cm x 122 cm)	1-5/8" (4.1 cm)	Expanded polystyrene

PROVA LINEAR PAN KIT® - END DRAIN

PROVA LINEAR PAN KIT® - END DRAIN

Pack Size: 1 kit

The PROVA LINEAR PAN KIT® for **end drain applications** features a unique modular pan and extension system that is easy to install with its pre-sloped base and perforated edges. Kit includes 2 pieces of PROVA LINEAR PAN®, 2 side supports, 2 filler strips and 2 pieces of PROVA LINEAR PAN EXTENSION® which can build up to a 48" x 48" linear shower base.

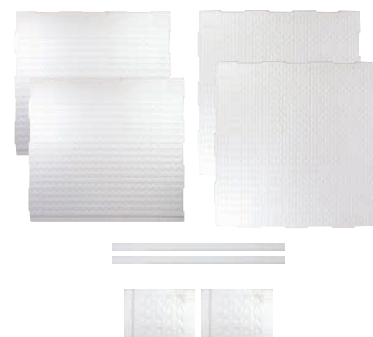

PART NO.	TOTAL PAN SIZE	THICKNESS	MATERIAL
TT8903END02	48" x 48" (122 cm x 122 cm)	1-5/8" (4.1 cm)	Expanded polystyrene

Note: PROVA® products are to be installed using premium polymer-modified thinset mortar only. Premixed mortar or mastic are not to be used. Installations completed with polymer-modified thinset mortar that meets the most current version of the ANSI A118.15 standard may qualify for a limited lifetime warranty. Refer to the warranty summary page on page 55, installation instructions and technical data sheets for complete product information & appropriate application conditions.



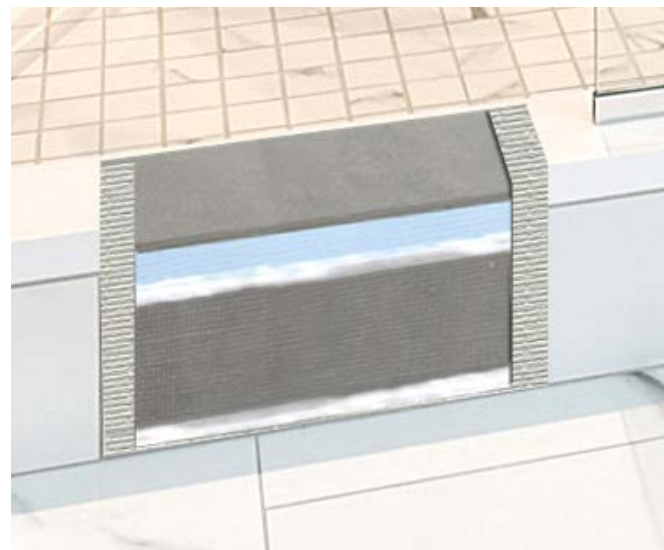
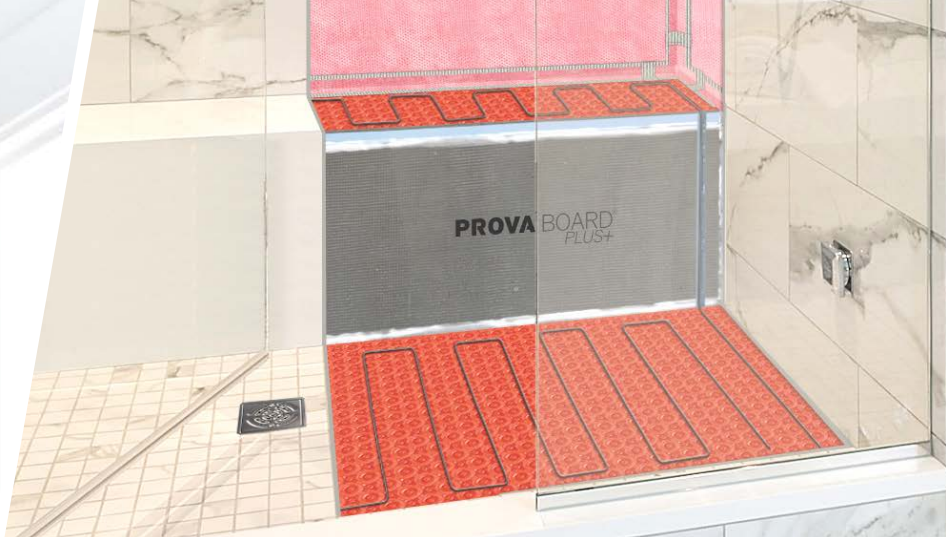

PROVA[®]

WATERPROOFING

Designed with the installer in mind, PROVA[®] makes waterproofing easier than ever before! There are two options available: PROVA-MAT[®] membrane and PROVA BOARD[®] PLUS tile backer. Both offerings are ideal for waterproofing a variety of different areas, such as showers, steam showers/saunas, countertops, backsplashes and more. Both options are lightweight and easy to install, protect against the growth of mold and mildew and are designed to ensure that you can produce an evenly waterproofed surface to tile every time!

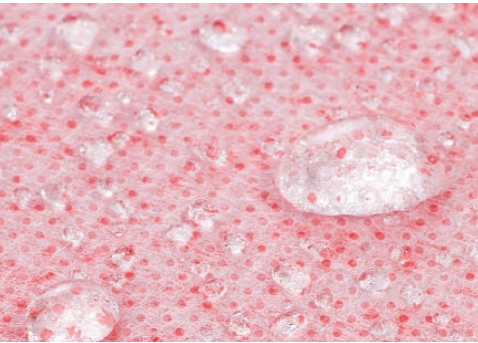

PROVA-MAT®

PROVA-MAT®

Pack Size: 1 roll

PROVA-MAT® is a low perm waterproof membrane that is ideal for use in wet areas, such as showers, bathrooms, laundry rooms, backsplashes, countertops and more. The easy-to-install membrane resists mold and mildew growth and provides great resistance to water vapor transmission. When installed over PROVA BOARD® PLUS, the waterproofing properties of the membrane and the thermal resistance offered by the backer board come together to produce the ultimate waterproofing solution for steam showers and saunas!

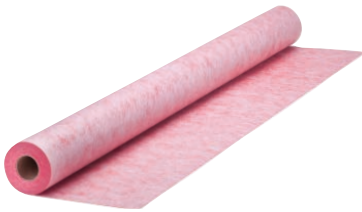

PART NO.	SIZE	COVERAGE AREA	THICKNESS	MATERIAL
TT8002RED05R	16' x 3.28' (5 m x 1 m)	54 sq. ft. (5 sq. m)	16.93 mil (0.43 mm)	Polypropylene
TT8002RED10R	33' x 3.28' (10 m x 1 m)	108 sq. ft. (10 sq. m)	16.93 mil (0.43 mm)	Polypropylene
TT8002RED25R	82' x 3.28' (25 m x 1 m)	269 sq. ft. (25 sq. m)	16.93 mil (0.43 mm)	Polypropylene



PROVA JOINT®

PROVA JOINT®

Pack Size: 1 roll

PROVA JOINT® waterproofing strip seals seams and transitions where water could penetrate. The joint strip also resists mold and mildew growth.



PART NO.	SIZE	THICKNESS	MATERIAL
TT8001RED25R	25' x 5" (7.62 m x 12.7 cm)	13.78 mil (0.35 mm)	Polypropylene
TT8001RED82R	82' x 5" (25 m x 12.7 cm)	13.78 mil (0.35 mm)	Polypropylene

Note: PROVA® products are to be installed using premium polymer-modified thinset mortar only. Premixed mortar or mastic are not to be used. Installations completed with polymer-modified thinset mortar that meets the most current version of the ANSI A118.15 standard may qualify for a limited lifetime warranty. Refer to the warranty summary page on page 55, installation instructions and technical data sheets for complete product information & appropriate application conditions.

PROVA CORNER®

PROVA CORNER® Pack Size: 4 pcs

PROVA CORNER® is made from PROVA-MAT® waterproofing membrane and is used to seal and waterproof the inside/outside corners of a shower base and curb. The preformed corner eliminates any seams. The corners also resist mold and mildew growth.

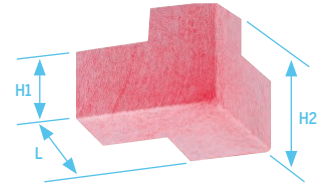
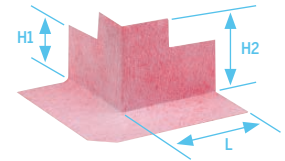

PART NO.	CORNER TYPE	SIZE (L x H1 x H2)	THICKNESS	MATERIAL
TT8003INSCR	Inside	4-1/2" x 2-1/4" x 3-1/2" (11.43 cm x 5.72 cm x 8.89 cm)	25.59 mil (0.65 mm)	Polypropylene
TT8003OUTCR	Outside	4-1/2" x 2-1/4" x 3-1/2" (11.43 cm x 5.72 cm x 8.89 cm)	25.59 mil (0.65 mm)	Polypropylene

PROVA PIPE SEAL®

PROVA PIPE SEAL® Pack Size: 1 pc

PROVA PIPE SEAL® is a prefabricated seal made of cut sections of PROVA-MAT® with a flexible collar designed to seal pipe protrusions. The pipe seal also resists mold and mildew growth.

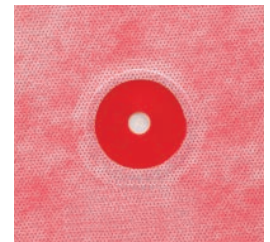

PART NO.	SIZE	THICKNESS	MATERIAL
TT8102REDPS	4-3/4" x 4-3/4" (12.07 cm x 12.07 cm), 7/16" (1.11 cm) opening	16.14 mil (0.41 mm)	Polypropylene

PROVA PIPE SEAL® - BULK Pack Size: 10 pcs

PART NO.	SIZE	THICKNESS	MATERIAL
TT8102REDPSB	4-3/4" x 4-3/4" (12.07 cm x 12.07 cm), 7/16" (1.11 cm) opening	16.14 mil (0.41 mm)	Polypropylene

Note: PROVA® products are to be installed using premium polymer-modified thinset mortar only. Premixed mortar or mastic are not to be used. Installations completed with polymer-modified thinset mortar that meets the most current version of the ANSI A118.15 standard may qualify for a limited lifetime warranty. Refer to the warranty summary page on page 55, installation instructions and technical data sheets for complete product information & appropriate application conditions.

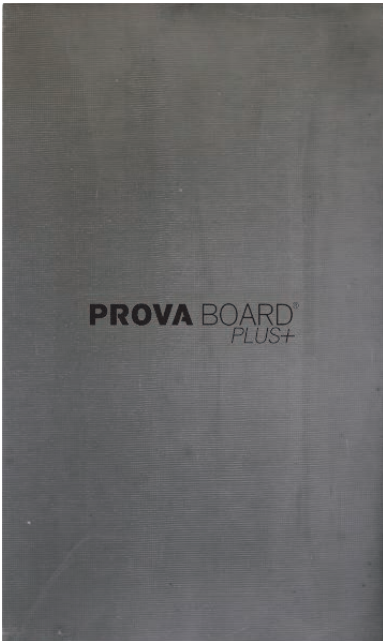

PROVA BOARD[®] PLUS+

PROVA BOARD[®] PLUS

PROVA BOARD[®] PLUS is a lightweight, high-density tile backer board that is quick and easy to install. The 100% waterproof XPS (extruded polystyrene) core is resistant to vapor pressure and does not support mold growth. The XPS core is sandwiched between tightly woven mesh and layers of cementitious coating. Install with PROVA FASTENERS[®] and PROVA-SEAL[™] to guarantee a watertight installation.

- Install on walls, countertops & fireplaces
- Great for tub surrounds, walk-in showers & building benches
- Offers support for large format tiles
- Non-deteriorating/non-rotting properties
- Highly durable & flame retardant

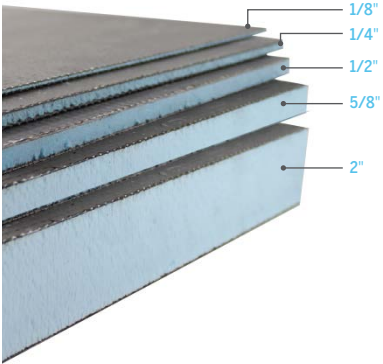
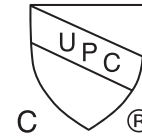

PART NO.	SIZE	THICKNESS	PACK SIZE	MATERIAL
PVBP24X48X12	24" x 48" (61 cm x 122 cm)	1/8" (3.2 mm)	10 pcs/box	Extruded polystyrene
PVBP36X60X25	36" x 60" (91 cm x 152 cm)	1/4" (6.4 mm)	10 pcs/box	Extruded polystyrene
PVBP36X60X05	36" x 60" (91 cm x 152 cm)	1/2" (12.7 mm)	5 pcs/box	Extruded polystyrene
PVBP36X60X05B	36" x 60" (91 cm x 152 cm)	1/2" (12.7 mm)	100 pcs/pallet	Extruded polystyrene
PVBP48X96X05	48" x 96" (122 cm x 244 cm)	1/2" (12.7 mm)	5 pcs/box	Extruded polystyrene
PVBP48X96X05B	48" x 96" (122 cm x 244 cm)	1/2" (12.7 mm)	100 pcs/pallet	Extruded polystyrene
PVBP48X96X58B	48" x 96" (122 cm x 244 cm)	5/8" (15.9 mm)	40 pcs/pallet	Extruded polystyrene
PVBP24X96X20	24" x 96" (61 cm x 244 cm)	2" (5 cm)	5 pcs/box	Extruded polystyrene

Common Uses (by board thickness)	2"	5/8"	1/2"	1/4"	1/8"
Building/Construction use	✓	✓	✓		
Structural use (i.e. benches)	✓				
Build-up for listellos and mosaics				✓	✓
Thermal break on concrete floors				✓	
Adapter and/or spacer		✓		✓	✓
Sound reduction properties	✓	✓	✓		

Note: PROVA[®] products are to be installed using premium polymer-modified thinset mortar only. Premixed mortar or mastic are not to be used. Installations completed with polymer-modified thinset mortar that meets the most current version of the ANSI A118.15 standard may qualify for a limited lifetime warranty. Refer to the warranty summary page on page 55, installation instructions and technical data sheets for complete product information & appropriate application conditions.

PROVA BOARD PAN ASSEMBLY KIT®

PROVA BOARD PAN ASSEMBLY KIT®

Pack Size: 1 kit

PROVA BOARD PAN ASSEMBLY KIT® includes all the components required to build a watertight shower pan assembly using PROVA BOARD® PLUS tile backer*. The kit is perfect for new construction or projects where existing drywall or cement board needs to be replaced. Save time with this combination solution and rest assured that your shower assembly will last for years to come!

- Eliminates the two-step process of waterproofing membrane over cement board and/or drywall
- Modular PROVA PAN® inclusion provides flexibility in installation and replaces the need for a mortar base
- PROVA-MAT PAN LINER® component is ICC-ES approved



*PROVA BOARD® PLUS sold separately.

PART NO.	SIZE	DRAIN PLACEMENT	DRAIN MATERIAL
PVBP8008ABS	48" x 48" (122 cm x 122 cm)	Center	ABS, includes 304 stainless steel grate
PVBP8013ABS	32" x 60" (81 cm x 152 cm)	Offset	ABS, includes 304 stainless steel grate
PVBP8008PVC	48" x 48" (122 cm x 122 cm)	Center	PVC, includes 304 stainless steel grate
PVBP8013PVC	32" x 60" (81 cm x 152 cm)	Offset	PVC, includes 304 stainless steel grate

EACH PROVA BOARD PAN ASSEMBLY KIT® INCLUDES:

LABELS	DESCRIPTION	SPECS	QTY
A	PROVA PAN®	48" x 48" (122 cm x 122 cm) or 32" x 60" (81 cm x 152 cm)	1 pc
B	PROVA-MAT PAN LINER®	48" x 48" (122 cm x 122 cm) or 32" x 60" (81 cm x 152 cm)	1 pc
C	PROVA DRAIN®	ABS or PVC (304 stainless steel grate included)	1 pc
D	PROVA FASTENERS®	1-5/8" (4.1 cm) screws 1-1/4" (3.2 cm) washers	140 screws/washers
E	PROVA-SEAL™	9.5 oz (280 ml)	7 tubes

*PROVA BOARD® PLUS sold separately.



48" x 48" (122 cm x 122 cm) Kit with ABS Drain, Center Placement



32" x 60" (81 cm x 152 cm) Kit with PVC Drain, Offset Placement

Note: PROVA® products are to be installed using premium polymer-modified thinset mortar only. Premixed mortar or mastic are not to be used. Installations completed with polymer-modified thinset mortar that meets the most current version of the ANSI A118.15 standard may qualify for a limited lifetime warranty. Refer to the warranty summary page on page 55, installation instructions and technical data sheets for complete product information & appropriate application conditions.



PROVA NICHE®

PROVA NICHE®

Pack Size: 1 pc

PROVA NICHE® is a prefabricated niche made of PROVA BOARD® PLUS that can be used with PROVAMAT® or PROVA BOARD® PLUS when installing a tiled shower. This useful, stylish accessory offers built-in utility for showers, bathrooms, and kitchen backsplashes. It also allows for more free and clear space for any and all necessities, such as shampoo bottles, soaps, spices, cooking utensils and more!

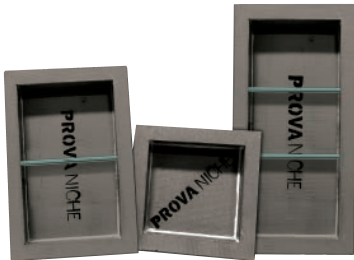

TT8801NCH24 TT8800NCH16 TT8800NCH33

PART NO.	SIZE (OUTSIDE DIMENSIONS)	SIZE (INSIDE DIMENSIONS)	GLASS SHELF	MATERIAL
TT8800NCH16	16" x 16" (40.6 cm x 40.6 cm)	12" x 12" (30.5 cm x 30.5 cm)	Sold separately	Extruded polystyrene
TT8801NCH24	24" x 16" (61 cm x 40.6 cm)	20" x 12" (50.8 cm x 30.5 cm)	1 included	Extruded polystyrene
TT8800NCH33	33" x 16" (83.8 cm x 40.6 cm)	29" x 12" (73.7 cm x 30.5 cm)	2 included	Extruded polystyrene

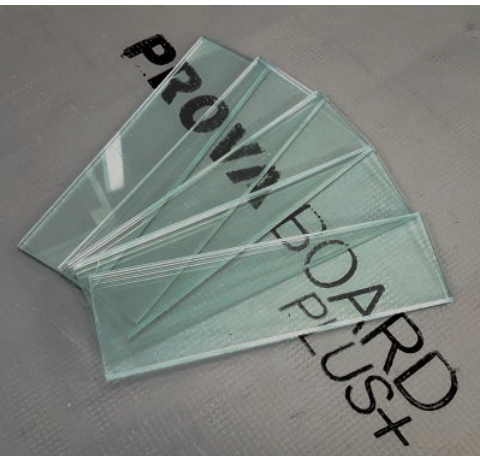

PROVA NICHE GLASS SHELF®

PROVA NICHE GLASS SHELF®

Pack Size: 5 pcs

Adjustable safety glass shelves for ultimate design flexibility and flair

- Easy to install & customize - position and trim shelves as desired
- Stylish - complements the interior décor of ANY bathroom
- Convenient & versatile - add shelves to an existing PROVA NICHE® or build your own niche with PROVA BOARD® PLUS
- Installation flexibility - Glass shelves can be trimmed to suit your needs

PART NO.	SIZE	THICKNESS	MATERIAL
TT8810GSS12	11-13/16" x 3-3/8" (30 cm x 8.6 cm)	3/8" (9.5 mm)	Laminated glass

Note: PROVA® products are to be installed using premium polymer-modified thinset mortar only. Premixed mortar or mastic are not to be used. Installations completed with polymer-modified thinset mortar that meets the most current version of the ANSI A118.15 standard may qualify for a limited lifetime warranty. Refer to the warranty summary page on page 55, installation instructions and technical data sheets for complete product information & appropriate application conditions.

PROVA-SEAL™

PROVA-SEAL™

Pack Size: 12 tubes/ctn

PROVA-SEAL™ is a 100% waterproof sealing and bonding compound. The sealant cures within one hour and even quicker in the presence of moisture or humidity. It creates a watertight, flexible seal that will not shrink, crack or crumble! PROVA-SEAL™ can be used to waterproof and seal pipe/valve protrusions in the PROVA-SHOWER SYSTEM® and is required for the installation of PROVA BOARD® PLUS. It is also great for sealing cracks, joints and seams around sinks, counters, hardboard and flashing, penetrations and more! Once applied, PROVA-SEAL™ can be painted in 30 minutes and exposed to water in one hour.

PART NO. (U.S. 🇺🇸)	VOLUME	MATERIAL
PBS10FLOZUS	9.5 fl. oz. (280 ml)	Premium hybrid silicone
PART NO. (CAN 🇨🇦)	VOLUME	MATERIAL
PBS10FLOCDN	9.5 fl. oz. (280 ml)	Premium hybrid silicone



PROVA FASTENERS®

PROVA FASTENERS®

Pack Size: 1 ctn

PROVA FASTENERS® (screws and washers) offer a safe, simple and durable installation solution for PROVA BOARD® PLUS wall panels. They are used to fasten PROVA BOARD® PLUS panels to wood stud framing and other substrates suitable for screw connections.

***Screws and washers sold separately.**



PART NO.	SIZE/CONTENTS	PCS/CTN
TT8019SCR03B	3" SCREWS To be used for installation of 2" thick PROVA BOARD® PLUS	200
TT8020SCR02B	1-5/8" SCREWS To be used for installation of 1/2", 5/8", 1/4" or 1/8" thick PROVA BOARD® PLUS	200
TT8021WSH01B	1-1/4" WASHERS To be used in conjunction with either size screw for all PROVA BOARD® PLUS installations	100
TT8022SCR02B	1-5/8" SCREWS To be used for installation of 1/2", 5/8", 1/4" or 1/8" thick PROVA BOARD® PLUS	1000
TT8023WSH01B	1-1/4" WASHERS To be used in conjunction with either size screw for all PROVA BOARD® PLUS installations	1000

Note: PROVA® products are to be installed using premium polymer-modified thinset mortar only. Premixed mortar or mastic are not to be used. Installations completed with polymer-modified thinset mortar that meets the most current version of the ANSI A118.15 standard may qualify for a limited lifetime warranty. Refer to the warranty summary page on page 55, installation instructions and technical data sheets for complete product information & appropriate application conditions.



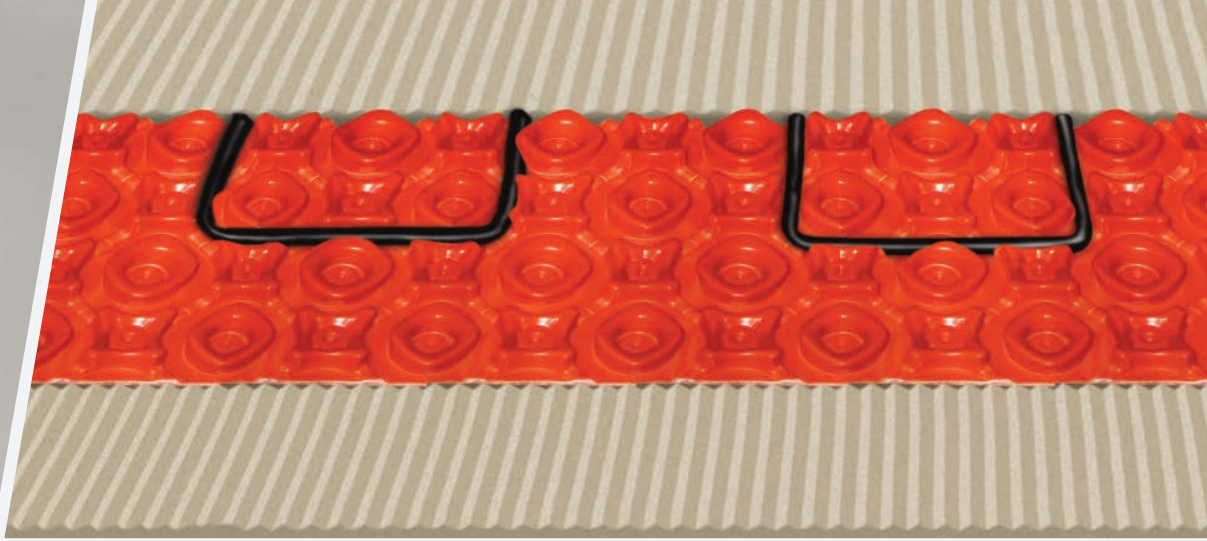

PROVA[®]

TILE UNDERLAYMENT SYSTEMS

PROVA[®] offers a variety of underlayment systems that provide protection and longevity of your tile installation. PROVA-FLEX[®], PROVA FLEX-HEAT[®] and PROTEGGA[®] PLUS offer easy, efficient methods for protecting tiled floors. All membranes are lightweight and offer superior strength, enabling installers to easily produce a strong surface for tiling in wet or dry areas. Featuring crack isolation and uncoupling properties, PROVA[®] underlayment systems can be used on or below grade. The versatility of PROVA FLEX-HEAT[®] provides a great solution for heated tile installations and also enables the installer to match up to thicker flooring surface materials like 3/4" (1.9 cm) hardwood.

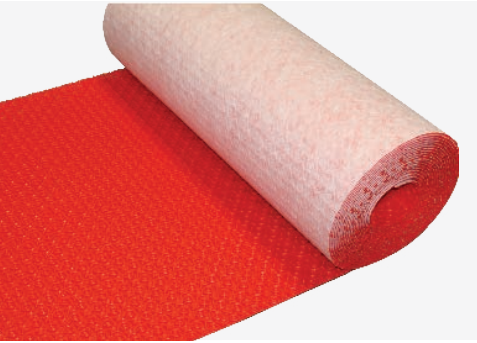

PROVA FLEX-HEAT+®

The ultimate versatility in tile underlayment

PROVA FLEX-HEAT® (ROLL)

Pack Size: 1 roll

PROVA FLEX-HEAT® is a lightweight uncoupling membrane with heating cable capabilities. The membrane features deep grooves with locking channels that are suitable for multiple thicknesses of heating cables. Patented **Shear Stress Control®** system with non-woven anchoring fleece neutralizes stress caused by movement in the substrate.

Versatile Heating Cable Compatibility:

Can be used with multiple wire sizes of up to 0.2" (5 mm) thick.

Achieve 3" (7.6 cm) Cable Spacing:

Provides most efficient heat distribution as per wire manufacturer specifications.

0.26" (6.5 mm) thick membrane:

Can be used without heating cables for matching up to higher floors to achieve a level transition.

Vapor Management System:

Open-air channels beneath the fleece layer provides a path for moisture to dissipate. Well suited for below-grade installations.

Achieved an EXTRA HEAVY Performance Rating When Tested to ASTM C627.

PART NO.	SIZE	COVERAGE AREA	THICKNESS	QTY/PALLET
TT8006RED05	3.28' x 16.40' (1 m x 5 m)	54 sq. ft. (5 sq. m)	0.26" (6.5 mm)	16 rolls
TT8006RED15	3.28' x 49.21' (1 m x 15 m)	161 sq. ft. (15 sq. m)	0.26" (6.5 mm)	9 rolls

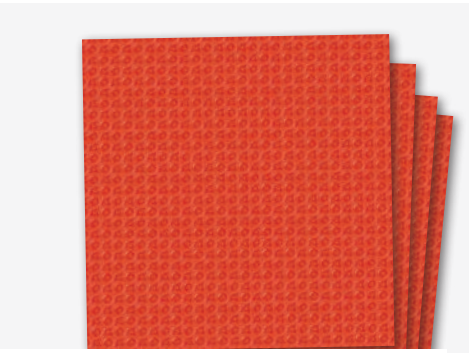

PROVA FLEX-HEAT® (SHEETS)

Pack Size: 10 pcs/box

PROVA FLEX-HEAT® pre-cut for easy handling and versatility. Perfect for numerous projects.

PART NO.	SIZE	COVERAGE AREA	THICKNESS	QTY/PALLET
TT8006RED10	38.75" x 37.25" (0.98 m x 0.95 m)	10 sq. ft. (0.93 sq. m)	0.26" (6.5 mm)	25 boxes

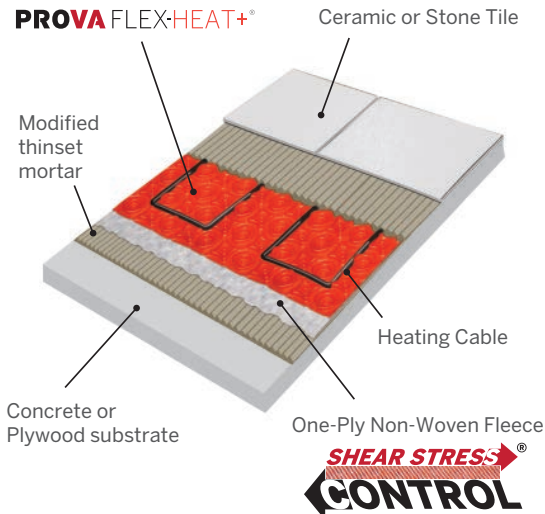

Note: PROVA® products are to be installed using premium polymer-modified thinset mortar only. Premixed mortar or mastic are not to be used. Installations completed with polymer-modified thinset mortar that meets the most current version of the ANSI A118.15 standard may qualify for a limited lifetime warranty. Refer to the warranty summary page on page 55, installation instructions and technical data sheets for complete product information & appropriate application conditions.

PROVA-FLEX®

PROVA FLEX®

Pack Size: 1 roll

PROVA-FLEX® is a durable, lightweight tile underlayment that provides crack isolation protection on cement slabs and is an easy-to-install, labor-saving alternative to backer board on wood substrates. The underlayment features a patented **Shear Stress Control®** system with non-woven anchoring fleece to neutralize stress caused by movement in the substrate. With its lightweight functionality and the top scrim layer that provides the ultimate locking mechanism for mortar, you can fill the studs with mortar in just one pass of your trowel and get the job done even faster!

Achieved an **EXTRA HEAVY** Performance Rating When Tested to ASTM C627.

PART NO.	SIZE	COVERAGE AREA	THICKNESS	QTY/PALLET
TT8004RED05	3.28' x 16.40' (1 m x 5 m)	54 sq. ft. (5 sq. m)	0.16" (4 mm)	25 rolls
TT8004RED82R	3.28' x 82.02' (1 m x 25 m)	269 sq. ft. (25 sq. m)	0.16" (4 mm)	9 rolls

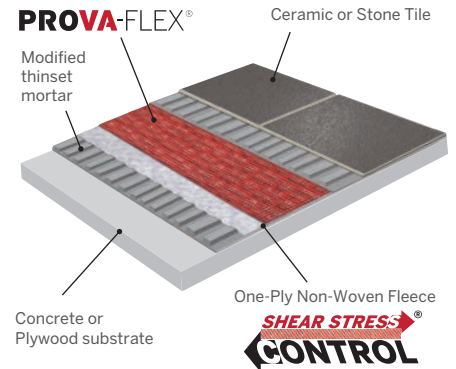

PROTEGGA® TILE UNDERLAYMENT PLUS+

PROTEGGA® PLUS

Pack Size: 1 roll

PROTEGGA® PLUS is a durable, lightweight tile underlayment that provides crack isolation protection on cement slabs and is an easy-to-install, labor saving alternative to backer board on wood substrates. The underlayment features a patented **Shear Stress Control®** system with non-woven anchoring fleece to neutralize stress caused by movement in the substrate. The exclusive waterproofing and vapour management system provides open-air channels on the underside to allow moisture to dissipate.

Achieved an **EXTRA HEAVY** Performance Rating When Tested to ASTM C627.
Exclusive for Canada.

PART NO.	SIZE	COVERAGE AREA	THICKNESS	QTY/PALLET
TT8000RED82R	3.28' x 82.02' (1 m x 25 m)	269 sq. ft. (25 sq. m)	0.16" (4 mm)	9 rolls

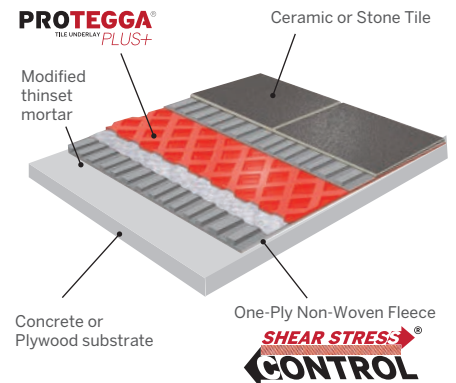

Note: PROVA® products are to be installed using premium polymer-modified thinset mortar only. Premixed mortar or mastic are not to be used. Installations completed with polymer-modified thinset mortar that meets the most current version of the ANSI A118.15 standard may qualify for a limited lifetime warranty. Refer to the warranty summary page on page 55, installation instructions and technical data sheets for complete product information & appropriate application conditions.





PROVA TILE EDGE[®]

TILE TRIM, NOSING & PROFILES

PROVA TILE EDGE[®] by M-D PRO offers a precise selection of the most popular profiles and finishes for both commercial and residential building projects. These profiles and finishes are among the most widely used and selected by installers, designers and architects in the industry.

With over 60 years of manufacturing aluminum and vinyl extrusions in North America, M-D PRO and the PROVA TILE EDGE[®] series are able to cover a broad spectrum of installation challenges with high quality, industry-approved products. The vast array of finishes and quick solutions provide assurance that no matter what the scope of the job, it will always be finished off just right with PROVA TILE EDGE[®].

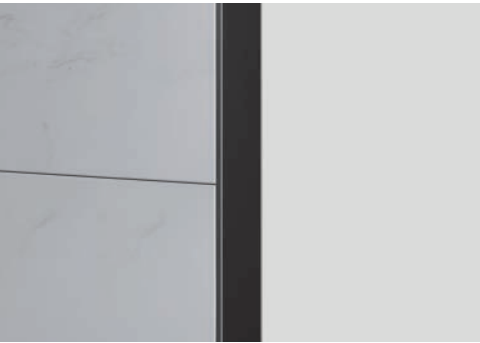

FLAT TILE EDGE Pack Size: 25 pcs

Flat Tile Edge protects tile from damage while providing a finished butting edge for other flooring materials. Prevents tiles from chipping and is pre-punched for easy setting into mortar.

8 ft. lengths also available in Contour (Flex) style 
 See page 33 for more details

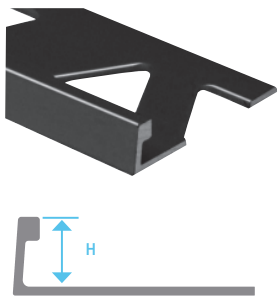

 Denotes ADA-compliant profiles

LENGTH: 8 ft. (2.4 m)		ALUMINUM FINISH/PART NO.			
Height (H)	Bright Brass (BBR)	Bright Clear (BCL)	Mill Finish (MIL)	Satin Antique Bronze (SAB)	
3/16" (4.5 mm)	N/A	N/A	CM2148MIL08 	N/A	
1/4" (6 mm)	N/A	CM2149BCL08 	CM2149MIL08 	CM2149SAB08 	
5/16" (8 mm)	CM2150BBR08	CM2150BCL08	CM2150MIL08	CM2150SAB08	
3/8" (10 mm)	CM2151BBR08	CM2151BCL08	CM2151MIL08	CM2151SAB08	
1/2" (12.5 mm)	CM2152BBR08	CM2152BCL08	CM2152MIL08	CM2152SAB08	
5/8" (16 mm)	N/A	CM2154BCL08	CM2154MIL08	N/A	
3/4" (19 mm)	N/A	CM2155BCL08	CM2155MIL08	N/A	
Height (H)	Satin Black (SBK)	Satin Clear Anodized (SCA)	Satin Champagne (SCP)	Satin Dark Bronze (SDB)	
3/16" (4.5 mm)	N/A	CM2148SCA08 	N/A	N/A	
1/4" (6 mm)	CM2149SBK08 	CM2149SCA08 	CM2149SCP08 	CM2149SDB08 	
5/16" (8 mm)	CM2150SBK08	CM2150SCA08	CM2150SCP08	CM2150SDB08	
3/8" (10 mm)	CM2151SBK08	CM2151SCA08	CM2151SCP08	CM2151SDB08	
1/2" (12.5 mm)	CM2152SBK08	CM2152SCA08	CM2152SCP08	CM2152SDB08	
5/8" (16 mm)	CM2154SBK08	CM2154SCA08	CM2154SCP08	N/A	
3/4" (19 mm)	CM2155SBK08	CM2155SCA08	CM2155SCP08	N/A	
Height (H)	Satin Gold Anodized (SGA)	Satin Titanium (STI)	White (WHT)		
3/16" (4.5 mm)	N/A	CM2148STI08 	N/A		
1/4" (6 mm)	CM2149SGA08 	CM2149STI08 	CM2149WHT08 		
5/16" (8 mm)	CM2150SGA08	CM2150STI08	CM2150WHT08		
3/8" (10 mm)	CM2151SGA08	CM2151STI08	CM2151WHT08		
1/2" (12.5 mm)	CM2152SGA08	CM2152STI08	CM2152WHT08		
5/8" (16 mm)	N/A	CM2154STI08	N/A		
3/4" (19 mm)	N/A	CM2155STI08	N/A		

Notes: Colours may not appear exactly as shown. Please request sample prior to placing an order. Additionally, due to the corrosive and caustic nature of certain ingredients in many grouts, it is imperative that any residue be immediately removed from the surface of the trim to prevent discoloration.

FLAT TILE EDGE

Pack Size: 25 pcs

Flat Tile Edge protects tile from damage while providing a finished butting edge for other flooring materials. Prevents tiles from chipping and is pre-punched for easy setting into mortar.

12 ft. lengths also available – minimize joints, reduce waste and perfect for high ceilings!



LENGTH: 12 ft. (3.7 m)		ALUMINUM FINISH/PART NO.	
Height (H)	Bright Clear (BCL)	Satin Black (SBK)	Satin Clear Anodized (SCA)
5/16" (8 mm)	CM2150BCL12	CM2150SBK12	CM2150SCA12
3/8" (10 mm)	CM2151BCL12	CM2151SBK12	CM2151SCA12
1/2" (12.5 mm)	CM2152BCL12	CM2152SBK12	CM2152SCA12
Height (H)	Satin Titanium (STI)	White (WHT)	
5/16" (8 mm)	CM2150STI12	CM2150WHT12	
3/8" (10 mm)	CM2151STI12	CM2151WHT12	
1/2" (12.5 mm)	CM2152STI12	CM2152WHT12	

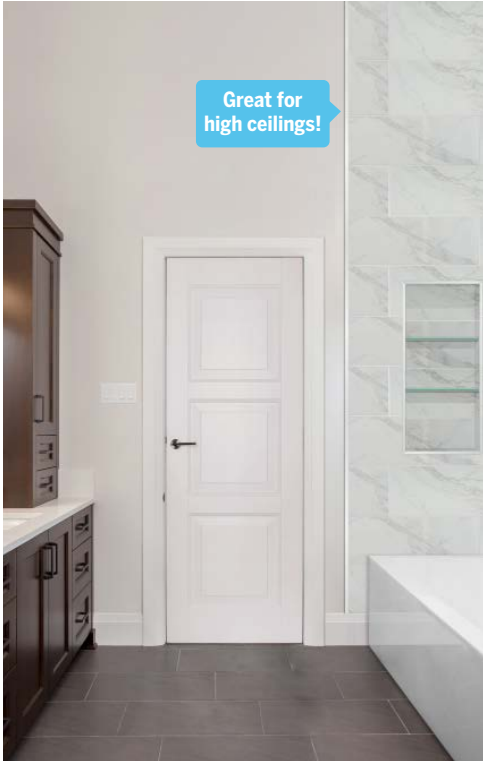

FLAT TILE EDGE (CONTOUR) 

Flat Tile Edge also available in a Contour (Flex) style where the setting flange is punched to allow trim to be molded and shaped around curved floor applications up to a 2' (61 cm) radius. Available profiles include CM2148, CM2149, CM2150, CM2151, CM2152, CM2154 and CM2155 in all aluminum finishes, 8 ft. lengths only.

NOTE: Adding "C" at the end of part number denotes contour (i.e. CM2148BBR08C). Contact customer service for availability and delivery time.

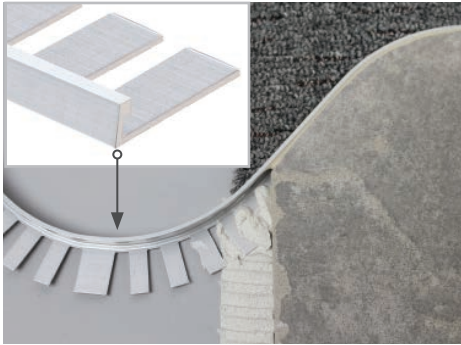

Notes: Colours may not appear exactly as shown. Please request sample prior to placing an order. Additionally, due to the corrosive and caustic nature of certain ingredients in many grouts, it is imperative that any residue be immediately removed from the surface of the trim to prevent discoloration.



ROUND TILE EDGE

Pack Size: 25 pcs

Round Tile Edge protects tile from damage while providing a finished curved edge. Can be used on walls, floors, countertops, and backsplashes. Prevents tiles from chipping and pre-punched for easy setting into mortar.

LENGTH: 8 ft. (2.4 m) ALUMINUM FINISH/PART NO.

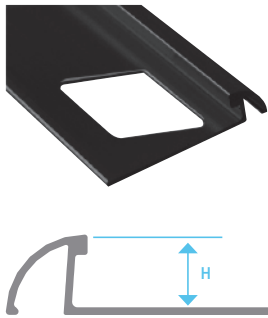

ADA Denotes ADA-compliant profiles

Height (H)	Bright Brass (BBR)	Bright Clear (BCL)	Mill Finish (MIL)	Satin Antique Bronze (SAB)
1/4" (6 mm)	CM2249BBR08 ^{ADA}	CM2249BCL08 ^{ADA}	CM2249MIL08 ^{ADA}	CM2249SAB08 ^{ADA}
5/16" (8 mm)	CM2250BBR08	CM2250BCL08	CM2250MIL08	CM2250SAB08
3/8" (10 mm)	CM2251BBR08	CM2251BCL08	CM2251MIL08	CM2251SAB08
1/2" (12.5 mm)	CM2252BBR08	CM2252BCL08	CM2252MIL08	CM2252SAB08
Height (H)	Satin Black (SBK)	Satin Clear Anodized (SCA)	Satin Champagne (SCP)	Satin Dark Bronze (SDB)
1/4" (6 mm)	N/A	CM2249SCA08 ^{ADA}	N/A	N/A
5/16" (8 mm)	CM2250SBK08	CM2250SCA08	CM2250SCP08	CM2250SDB08
3/8" (10 mm)	CM2251SBK08	CM2251SCA08	CM2251SCP08	CM2251SDB08
1/2" (12.5 mm)	CM2252SBK08	CM2252SCA08	CM2252SCP08	CM2252SDB08
Height (H)	Satin Gold Anodized (SGA)	Satin Titanium (STI)	White (WHT)	
1/4" (6 mm)	CM2249SGA08 ^{ADA}	CM2249STI08 ^{ADA}	N/A	
5/16" (8 mm)	CM2250SGA08	CM2250STI08	N/A	
3/8" (10 mm)	N/A	CM2251STI08	CM2251WHT08	
1/2" (12.5 mm)	N/A	CM2252STI08	CM2252WHT08	

Notes: Colours may not appear exactly as shown. Please request sample prior to placing an order. Additionally, due to the corrosive and caustic nature of certain ingredients in many grouts, it is imperative that any residue be immediately removed from the surface of the trim to prevent discoloration.

ROUND OUTSIDE CORNER Pack Size: 10 pcs

Round Outside Corner used to finish and protect the outer corner edge while joining two pieces of round tile edge at a 90° outside corner. Can be used on walls, countertops, and backsplashes. Prevents tiles from chipping.

BULK		ALUMINUM FINISH/PART NO.		
Height (H)	Satin Antique Bronze (SAB)	Satin Clear Anodized (SCA)	Satin Titanium (STI)	
5/16" (8 mm)	CM5008SABOC	CM5008SCAOCR	CM5008STIOCR	
3/8" (10 mm)	CM5110SABOC	CM5110SCAOCR	CM5110STIOCR	
1/2" (12.5 mm)	CM5212SABOC	CM5212SCAOCR	CM5212STIOCR	

PACKAGED		ALUMINUM FINISH/PART NO.		
Height (H)	Satin Antique Bronze (SAB)	Satin Clear Anodized (SCA)	Satin Titanium (STI)	
5/16" (8 mm)	ET5008SABOC	ET5008SCAOC	ET5008STIOC	
3/8" (10 mm)	ET5110SABOC	ET5110SCAOC	ET5110STIOC	
1/2" (12.5 mm)	ET5212SABOC	ET5212SCAOC	ET5212STIOC	

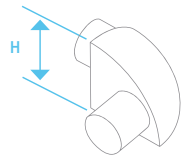

ROUND INSIDE CORNER Pack Size: 10 pcs

Round Inside Corner used to finish and join two pieces of tile edge at a 90° inside corner. Can be used on walls, countertops, and backsplashes. Prevents tiles from chipping.

BULK		ALUMINUM FINISH/PART NO.		
Height (H)	Satin Antique Bronze (SAB)	Satin Clear Anodized (SCA)	Satin Titanium (STI)	
5/16" (8 mm)	CM5008SABIC	CM5008SCAIC	CM5008STIIC	
3/8" (10 mm)	CM5110SABIC	CM5110SCAIC	CM5110STIIC	
1/2" (12.5 mm)	CM5212SABIC	CM5212SCAIC	CM5212STIIC	

PACKAGED		ALUMINUM FINISH/PART NO.		
Height (H)	Satin Antique Bronze (SAB)	Satin Clear Anodized (SCA)	Satin Titanium (STI)	
5/16" (8 mm)	ET5008SABIC	ET5008SCAIC	ET5008STIIC	
3/8" (10 mm)	ET5110SABIC	ET5110SCAIC	ET5110STIIC	
1/2" (12.5 mm)	ET5212SABIC	ET5212SCAIC	ET5212STIIC	

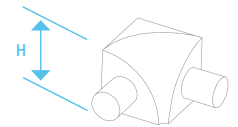

Notes: Colours may not appear exactly as shown. Please request sample prior to placing an order. Additionally, due to the corrosive and caustic nature of certain ingredients in many grouts, it is imperative that any residue be immediately removed from the surface of the trim to prevent discoloration.

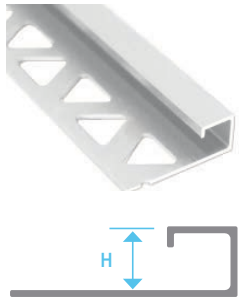

SQUARE TILE EDGE

Pack Size: 25 pcs

Square Tile Edge provides a sleek, contemporary look to finish and protect the outer edge of exposed tile. Can be used on walls, countertops, and backsplashes. This profile can also be used as an accent with a feature strip or listello border. Prevents tiles from chipping and is pre-punched for easy setting into mortar.

LENGTH: 8 ft. (2.4 m) ALUMINUM FINISH/PART NO.

Height (H)	Bright Clear (BCL)	Satin Antique Bronze (SAB)	Satin Clear Anodized (SCA)	Satin Titanium (STI)	White (WHT)
5/16" (8 mm)	CM2350BCL08	CM2350SAB08	CM2350SCA08	CM2350STI08	N/A
3/8" (10 mm)	CM2351BCL08	CM2351SAB08	CM2351SCA08	CM2351STI08	CM2351WHT08
1/2" (12.5 mm)	CM2352BCL08	N/A	CM2352SCA08	CM2352STI08	CM2352WHT08

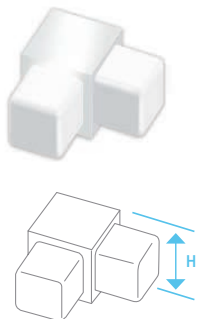

SQUARE CORNER

Pack Size: 10 pcs

Dual-purpose Square Corner can be used for both inside and outside corner applications. Provides a clean, finished look while also protecting corner edges of exposed tile.

BULK ALUMINUM FINISH/PART NO.

Height (H)	Application	Bright Clear (BCL)	Satin Clear Anodized (SCA)	Satin Titanium (STI)
5/16" (8 mm)	Dual purpose	CM2350BCLCR	CM2350SCACR	CM2350STICR
3/8" (10 mm)	Dual purpose	CM2351BCLCR	CM2351SCACR	CM2351STICR
1/2" (12.5 mm)	Dual purpose	CM2352BCLCR	CM2352SCACR	CM2352STICR

PACKAGED ALUMINUM FINISH/PART NO.

Height (H)	Application	Bright Clear (BCL)	Satin Clear Anodized (SCA)	Satin Titanium (STI)
5/16" (8 mm)	Dual purpose	ET2350BCLCR	ET2350SCACR	ET2350STICR
3/8" (10 mm)	Dual purpose	ET2351BCLCR	ET2351SCACR	ET2351STICR
1/2" (12.5 mm)	Dual purpose	ET2352BCLCR	ET2352SCACR	ET2352STICR

Notes: Colours may not appear exactly as shown. Please request sample prior to placing an order. Additionally, due to the corrosive and caustic nature of certain ingredients in many grouts, it is imperative that any residue be immediately removed from the surface of the trim to prevent discoloration.

CERAMIC COVE Pack Size: 12 pcs

Ceramic Cove is designed for sanitary base applications to prevent dirt buildup in open joints. Can be used for floor-to-wall and/or countertop-to-backsplash applications. Commonly used in commercial kitchens, washrooms or any tiled surface where sanitation is necessary.

LENGTH: 8 ft. (2.4 m) ALUMINUM FINISH/PART NO.

Height (H)	Bright Clear (BCL)	Satin Clear Anodized (SCA)	Satin Titanium (STI)
5/16" (8 mm)	CM2450BCL08	CM2450SCA08	CM2450STI08
3/8" (10 mm)	CM2451BCL08	CM2451SCA08	CM2451STI08
1/2" (12.5 mm)	CM2452BCL08	CM2452SCA08	CM2452STI08

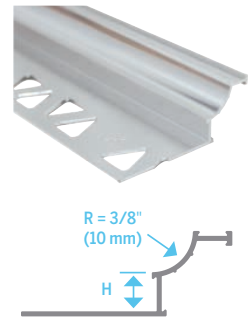
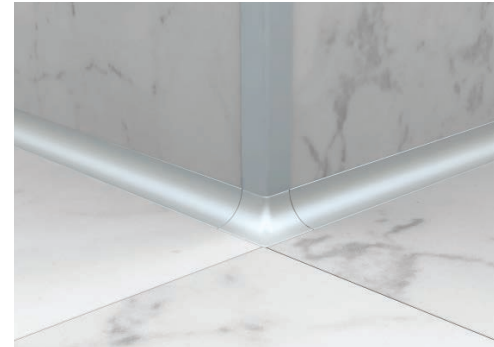

CERAMIC COVE CORNER Pack Size: 10 pcs

The **"one size fits all"** inside and outside Ceramic Cove Corner accessory pieces provide a finished corner edge at a 90° angle while also preventing the collection of dirt buildup with their matching cove shape. Can easily be wiped clean for a low-maintenance tile assembly.

BULK ALUMINUM FINISH/PART NO.

Application	Bright Clear (BCL)	Satin Clear Anodized (SCA)	Satin Titanium (STI)
Outside	CM2400BCLOCR	CM2400SCAOCR	CM2400STIOCR
Inside	CM2400BCLICR	CM2400SCAICR	CM2400STIICR

PACKAGED ALUMINUM FINISH/PART NO.

Application	Bright Clear (BCL)	Satin Clear Anodized (SCA)	Satin Titanium (STI)
Outside	ET2400BCLOCR	ET2400SCAOCR	ET2400STIOCR
Inside	ET2400BCLICR	ET2400SCAICR	ET2400STIICR

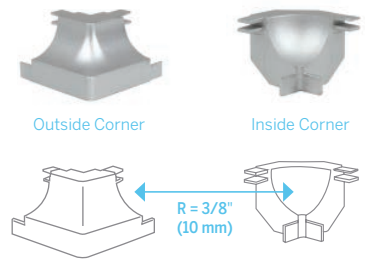
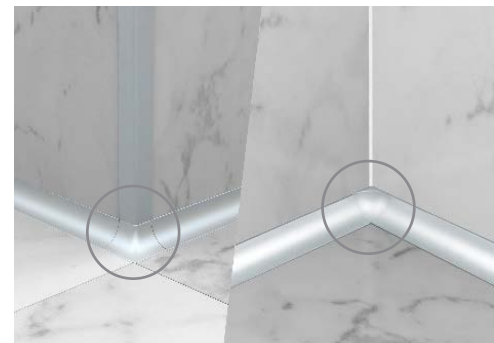

Notes: Colours may not appear exactly as shown. Please request sample prior to placing an order. Additionally, due to the corrosive and caustic nature of certain ingredients in many grouts, it is imperative that any residue be immediately removed from the surface of the trim to prevent discoloration.

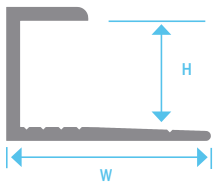
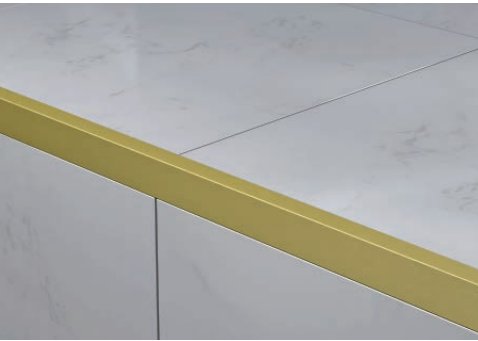

J-MOLDING

Pack Size: 12 pcs

J-Molding can be used to cap off tile edge. Can also be used to frame around glass, mirrors and panels. Prevents tiles from chipping.

LENGTH: 8 ft. (2.4 m)

ALUMINUM FINISH/PART NO.

Height (H)	Width (W)	Bright Brass (BBR)	Bright Clear (BCL)	Mill Finish (MIL)	Satin Clear Anodized (SCA)
1/4" (6 mm)	3/4" (19 mm)	CM2130BBR08	CM2130BCL08	CM2130MIL08	CM2130SCA08
3/8" (10 mm)	3/4" (19 mm)	N/A	CM2135BCL08	CM2135MIL08	CM2135SCA08
1/2" (12.5 mm)	1" (25 mm)	CM2136BBR08	CM2136BCL08	CM2136MIL08	CM2136SCA08
Height (H)	Width (W)	Satin Champagne (SCP)	Satin Gold Anodized (SGA)	Satin Titanium (STI)	
1/4" (6 mm)	3/4" (19 mm)	CM2130SCP08	N/A	CM2130STI08	
3/8" (10 mm)	3/4" (19 mm)	N/A	CM2135SGA08	CM2135STI08	
1/2" (12.5 mm)	1" (25 mm)	N/A	CM2136SGA08	CM2136STI08	

Notes: Colours may not appear exactly as shown. Please request sample prior to placing an order. Additionally, due to the corrosive and caustic nature of certain ingredients in many grouts, it is imperative that any residue be immediately removed from the surface of the trim to prevent discoloration.

CERAMIC ADAPTER

Pack Size: 12 pcs

Ceramic Adapter for use where tile meets low pile carpet, LVT/LVP or other 1/4" (6 mm) flooring material. Designed to cover the edge of the adjacent flooring material while also serving to protect unfinished tile edge. Pre-punched for easy setting into mortar.

LENGTH: 8 ft. (2.4 m) ALUMINUM FINISH/PART NO.

Height (H)	Bright Brass (BBR)	Bright Clear (BCL)	Mill Finish (MIL)	Satin Antique Bronze (SAB)
5/16" (8 mm)	CM2160BBR08 ^{ADA}	CM2160BCL08 ^{ADA}	CM2160MIL08 ^{ADA}	CM2160SAB08 ^{ADA}
3/8" (10 mm)	CM2161BBR08 ^{ADA}	CM2161BCL08 ^{ADA}	CM2161MIL08 ^{ADA}	CM2160SAB08 ^{ADA}
1/2" (12.5 mm)	N/A	CM2162BCL08 ^{ADA}	CM2162MIL08 ^{ADA}	CM2162SAB08 ^{ADA}
Height (H)	Satin Black (SBK)	Satin Clear Anodized (SCA)	Satin Champagne (SCP)	Satin Dark Bronze (SDB)
5/16" (8 mm)	CM2160SBK08 ^{ADA}	CM2160SCA08 ^{ADA}	N/A	CM2160SDB08 ^{ADA}
3/8" (10 mm)	CM2161SBK08 ^{ADA}	CM2161SCA08 ^{ADA}	CM2161SCP08 ^{ADA}	CM2161SDB08 ^{ADA}
1/2" (12.5 mm)	CM2162SBK08 ^{ADA}	CM2162SCA08 ^{ADA}	CM2162SCP08 ^{ADA}	CM2162SDB08 ^{ADA}
Height (H)	Satin Gold Anodized (SGA)	Satin Titanium (STI)		
5/16" (8 mm)	CM2160SGA08 ^{ADA}	CM2160STI08 ^{ADA}		
3/8" (10 mm)	CM2161SGA08 ^{ADA}	CM2161STI08 ^{ADA}		
1/2" (12.5 mm)	N/A	CM2162STI08 ^{ADA}		

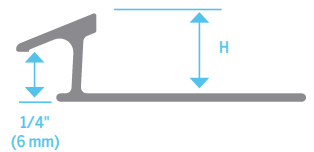

^{ADA} Denotes ADA-compliant profiles

Notes: Colours may not appear exactly as shown. Please request sample prior to placing an order. Additionally, due to the corrosive and caustic nature of certain ingredients in many grouts, it is imperative that any residue be immediately removed from the surface of the trim to prevent discoloration.



CERAMIC REDUCER

Pack Size: 12 pcs

Ceramic Reducer has a sloped face to create a smooth transition between tile and adjacent flooring material, such as LVT/LVP, resilient tile or sheet goods. Pre-punched for easy setting into mortar.

LENGTH: 8 ft. (2.4 m) ALUMINUM FINISH/PART NO.

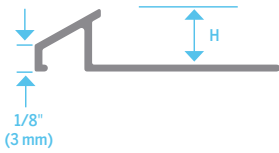

ADA Denotes ADA-compliant profiles

Height (H)	Bright Brass (BBR)	Bright Clear (BCL)	Mill Finish (MIL)	Satin Antique Bronze (SAB)
5/16" (8 mm)	N/A	CM2170BCL08 ^{ADA}	CM2170MIL08 ^{ADA}	CM2170SAB08 ^{ADA}
3/8" (10 mm)	CM2171BBR08 ^{ADA}	CM2171BCL08 ^{ADA}	CM2171MIL08 ^{ADA}	CM2171SAB08 ^{ADA}
1/2" (12.5 mm)	CM2172BBR08 ^{ADA}	CM2172BCL08 ^{ADA}	CM2172MIL08 ^{ADA}	CM2172SAB08 ^{ADA}
Height (H)	Satin Black (SBK)	Satin Clear Anodized (SCA)	Satin Champagne (SCP)	Satin Dark Bronze (SDB)
5/16" (8 mm)	CM2170SBK08 ^{ADA}	CM2170SCA08 ^{ADA}	CM2170SCP08 ^{ADA}	CM2170SDB08 ^{ADA}
3/8" (10 mm)	CM2171SBK08 ^{ADA}	CM2171SCA08 ^{ADA}	CM2171SCP08 ^{ADA}	CM2171SDB08 ^{ADA}
1/2" (12.5 mm)	CM2172SBK08 ^{ADA}	CM2172SCA08 ^{ADA}	CM2172SCP08 ^{ADA}	CM2172SDB08 ^{ADA}
Height (H)	Satin Gold Anodized (SGA)	Satin Titanium (STI)		
5/16" (8 mm)	CM2170SGA08 ^{ADA}	CM2170STI08 ^{ADA}		
3/8" (10 mm)	CM2171SGA08 ^{ADA}	CM2171STI08 ^{ADA}		
1/2" (12.5 mm)	CM2172SGA08 ^{ADA}	CM2172STI08 ^{ADA}		

Notes: Colours may not appear exactly as shown. Please request sample prior to placing an order. Additionally, due to the corrosive and caustic nature of certain ingredients in many grouts, it is imperative that any residue be immediately removed from the surface of the trim to prevent discoloration.

CERAMIC TILE STAIR NOSING

Pack Size: 12 pcs

Ceramic Tile Stair Nosing provides increased strength and rigidity to stairs while also serving to protect unfinished tile edge. The long inside drop covers the nose of standard stairs and gives a smooth, clean appearance. Can be used in light commercial and/or residential applications. Pre-punched for easy setting into mortar.

LENGTH: 6 ft. (1.8 m)		ALUMINUM FINISH/PART NO.			
Height 1 (H1)	Height 2 (H2)	Hammered Antique Bronze (HAB)*	Hammered Bright Brass (HBB)*	Hammered Bright Clear (HBC)*	Hammered Black (HBK)*
5/16" (8 mm)	1-5/8" (41 mm)	CM4050HAB06 SP	CM4050HBB06	CM4050HBC06	N/A
3/8" (10 mm)	1-5/8" (41 mm)	CM4051HAB06 SP	N/A	CM4051HBC06	N/A
1/2" (12.5 mm)	1-5/8" (41 mm)	CM4052HAB06 SP	N/A	CM4052HBC06	N/A
3/8" (10 mm)	2" (51 mm)	CM4251HAB06 SP	N/A	CM4251HBC06	CM4251HBK06 SP
Height 1 (H1)	Height 2 (H2)	Hammered Clear Anodized (HCA)*	Hammered Dark Bronze (HDB)*	Hammered Gold Anodized (HGA)*	Hammered Titanium (HTI)*
5/16" (8 mm)	1-5/8" (41 mm)	CM4050HCA06	N/A	N/A	CM4050HTI06
3/8" (10 mm)	1-5/8" (41 mm)	CM4051HCA06	CM4051HDB06	CM4051HGA06	CM4051HTI06
1/2" (12.5 mm)	1-5/8" (41 mm)	CM4052HCA06	CM4052HDB06	N/A	CM4052HTI06
3/8" (10 mm)	2" (51 mm)	CM4251HCA06	CM4251HDB06	CM4251HGA06	CM4251HTI06

LENGTH: 12 ft. (3.7 m)		ALUMINUM FINISH/PART NO.			
Height 1 (H1)	Height 2 (H2)	Hammered Antique Bronze (HAB)*	Hammered Bright Brass (HBB)*	Hammered Bright Clear (HBC)*	Hammered Black (HBK)*
5/16" (8 mm)	1-5/8" (41 mm)	CM4050HAB12 SP	CM4050HBB12	CM4050HBC12	N/A
3/8" (10 mm)	1-5/8" (41 mm)	CM4051HAB12 SP	N/A	CM4051HBC12	N/A
1/2" (12.5 mm)	1-5/8" (41 mm)	CM4052HAB12 SP	N/A	CM4052HBC12	N/A
3/8" (10 mm)	2" (51 mm)	CM4251HAB12 SP	N/A	CM4251HBC12	CM4251HBK12
Height 1 (H1)	Height 2 (H2)	Hammered Clear Anodized (HCA)*	Hammered Dark Bronze (HDB)*	Hammered Gold Anodized (HGA)*	Hammered Titanium (HTI)*
5/16" (8 mm)	1-5/8" (41 mm)	CM4050HCA12	N/A	N/A	CM4050HTI12
3/8" (10 mm)	1-5/8" (41 mm)	CM4051HCA12	CM4051HDB12	CM4051HGA12	CM4051HTI12
1/2" (12.5 mm)	1-5/8" (41 mm)	CM4052HCA12	CM4052HDB12	N/A	CM4052HTI12
3/8" (10 mm)	2" (51 mm)	CM4251HCA12	CM4251HDB12	CM4251HGA12	CM4251HTI12

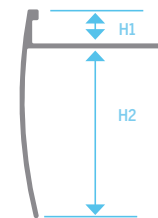
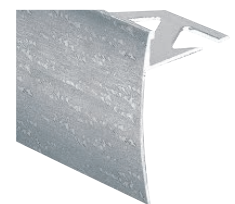

SP Special orders only

* Hammered texture

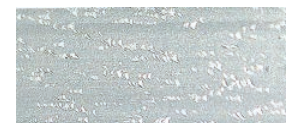

Notes: Colours may not appear exactly as shown. Please request sample prior to placing an order. Additionally, due to the corrosive and caustic nature of certain ingredients in many grouts, it is imperative that any residue be immediately removed from the surface of the trim to prevent discoloration.



DECORATIVE TILE STAIR NOSING

Pack Size: 12 pcs

Decorative Tile Stair Nosing provides increased strength and rigidity to stairs while also serving to protect unfinished tile edge. The long inside drop covers the nose of standard stairs and gives a smooth, clean appearance. Can be used in light commercial and/or residential applications. Pre-punched for easy setting into mortar.

LENGTH: 12 ft. (3.7 m)

ALUMINUM FINISH/PART NO.

Height (H)	Satin Black (SBK)	Satin Clear Anodized (SCA)	Satin Titanium (STI)
3/8" (10 mm)	CM4551SBK12 ^{SP}	CM4551SCA12	CM4551STI12
1/2" (12.5 mm)	CM4552SBK12 ^{SP}	CM4552SCA12	CM4552STI12

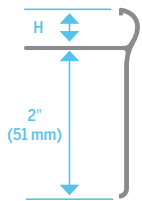

^{SP} Special orders only



DUAL-PURPOSE DECORATIVE EDGING

Pack Size: 6 pcs

Dual-Purpose Decorative Edging for use with countertops, raised platforms and stairs. Versatile profile can be used with both 3/8" (10 mm) and 1/2" (12.5 mm) tile. Pre-punched for easy setting into mortar.

LENGTH: 8 ft. (2.4 m)

ALUMINUM FINISH/PART NO.

Height (H)	Bright Clear (BCL)	Satin Black (SBK)	Satin Clear Anodized (SCA)
3/8" (10 mm)	CM4151BCL08	CM4151SBK08	CM4151SCA08
Height (H)	Satin Champagne (SCP)	Satin Dark Bronze (SDB)	Satin Titanium (STI)
3/8" (10 mm)	CM4151CAP08	CM4151SDB08	CM4151STI08

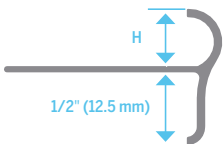
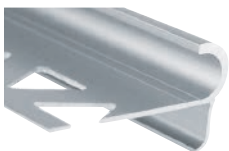

Notes: Colours may not appear exactly as shown. Please request sample prior to placing an order. Additionally, due to the corrosive and caustic nature of certain ingredients in many grouts, it is imperative that any residue be immediately removed from the surface of the trim to prevent discoloration.

COUNTERTOP/STAIR NOSING Pack Size: 6 pcs

Countertop/Stair Nosing provides a decorative finish while protecting the edge of tile or stone from chips and dents. The curved top provides a round edge for a smooth, clean appearance. Meets building code for use on stairs and is pre-punched for easy setting into mortar.

Height (H)	ALUMINUM FINISH/PART NO.	
	Satin Clear Anodized (SCA)	Satin Titanium (STI)
3/8" (10 mm)	CM4152SCA08 	CM4152STI08 
1/2" (12.5 mm)	CM4153SCA08 	CM4153STI08 

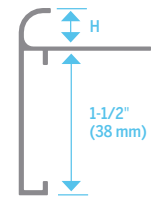
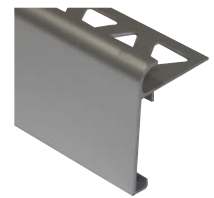

 Denotes ADA-compliant profiles

COUNTERTOP CORNER Pack Size: 1 pc

Countertop Inside & Outside Corners to be used with the Countertop/Stair Nosing profile. Provides a protective corner edge and finished look.

SIZE (INSIDE CORNER)	ALUMINUM FINISH/PART NO.	
Height (H)	Satin Clear Anodized (SCA)	Satin Titanium (STI)
3/8" (10 mm)	CM4152SCA0CR	CM4152STI0CR
1/2" (12.5 mm)	CM4153SCA0CR	CM4153STI0CR

SIZE (OUTSIDE CORNER)	ALUMINUM FINISH/PART NO.	
Height (H)	Satin Clear Anodized (SCA)	Satin Titanium (STI)
3/8" (10 mm)	CM4152SCAICR	CM4152SCAICR
1/2" (12.5 mm)	CM4153SCAICR	CM4153SCAICR

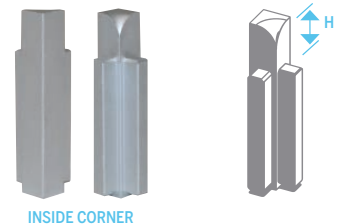

INSIDE CORNER

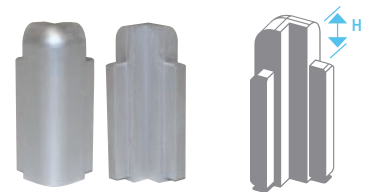

OUTSIDE CORNER



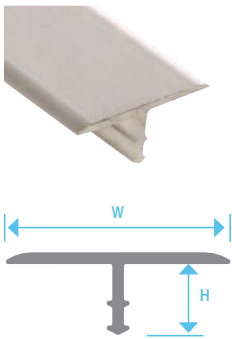





Notes: Colours may not appear exactly as shown. Please request sample prior to placing an order. Additionally, due to the corrosive and caustic nature of certain ingredients in many grouts, it is imperative that any residue be immediately removed from the surface of the trim to prevent discoloration.



ADA Denotes ADA-compliant profiles

T-MOLDING Pack Size: 12 pcs

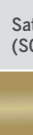
T-Molding can be used between ceramic, hardwood, laminate and LVT/LVP floors of equal heights and where expansion is expected to occur over time.

LENGTH: 8 ft. (2.4 m)		ALUMINUM FINISH/PART NO.		
Height (H)	Width (W)	Bright Brass (BBR)	Bright Clear (BCL)	Mill Finish (MIL)
5/16" (8 mm)	7/8" (22.2 mm)	 CM1156BBR08 ^{ADA}	 CM1156BCL08 ^{ADA}	 CM1156MIL08 ^{ADA}
Height (H)	Width (W)	Satin Black (SBK)	Satin Clear Anodized (SCA)	Satin Champagne (SCP)
5/16" (8 mm)	7/8" (22.2 mm)	 CM1156SBK08 ^{ADA}	 CM1156SCA08 ^{ADA}	 CM1156SCP08 ^{ADA}
Height (H)	Width (W)	Satin Dark Bronze (SDB)	Satin Gold Anodized (SGA)	Satin Titanium (STI)
5/16" (8 mm)	7/8" (22.2 mm)	 CM1156SDB08 ^{ADA}	 CM1156SGA08 ^{ADA}	 CM1156STI08 ^{ADA}

LENGTH: 9 ft. (2.7 m)		ALUMINUM FINISH/PART NO.	
Height (H)	Width (W)	Satin Clear Anodized (SCA)	Satin Titanium (STI)
3/8" (10 mm)	1-1/4" (32 mm)	 CM1159SCA09 ^{ADA}	 CM1159STI09 ^{ADA}

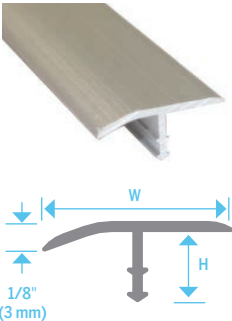



ADA Denotes ADA-compliant profiles

T-MOLDING REDUCER Pack Size: 12 pcs

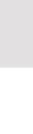
T-Molding Reducer is the perfect choice for flooring applications of unequal heights and where expansion is expected. Thin profile can be used to fill an expansion joint while the sleek top face creates a smooth transition between ceramic, hardwood, laminate and LVT/LVP floors. The profile reduces down by 1/8" (3 mm) to accommodate other flooring material.

LENGTH: 8 ft. (2.4 m)		ALUMINUM FINISH/PART NO.	
Height (H)	Width (W)	Satin Clear Anodized (SCA)	Satin Titanium (STI)
5/16" (8 mm)	7/8" (22.2 mm)	 CM1158SCA08 ^{ADA}	 CM1158STI08 ^{ADA}

LENGTH: 9 ft. (2.7 m)		ALUMINUM FINISH/PART NO.	
Height (H)	Width (W)	Satin Clear Anodized (SCA)	Satin Titanium (STI)
3/8" (10 mm)	1-1/4" (32 mm)	 CM1160SCA09 ^{ADA}	 CM1160STI09 ^{ADA}

Notes: Colours may not appear exactly as shown. Please request sample prior to placing an order. Additionally, due to the corrosive and caustic nature of certain ingredients in many grouts, it is imperative that any residue be immediately removed from the surface of the trim to prevent discoloration.

ANTI-SKID STAIR NOSING Pack Size: 5 pcs

Anti-Skid Stair Nosing for stairways with high traffic and/or wet areas. Vinyl insert is placed into the aluminum base to form a sturdy, long-lasting stair nose. Can be used in heavy-duty commercial applications.

Vinyl insert included (replacements sold separately).

LENGTH: 6 ft. (1.8 m)		VINYL INSERT COLORS/PART NO.			
Height (H)	Width (W)	Beige (BGE)	Black (BLK)	Brown (BRN)	Grey (GRY)
3/8" (10 mm)	1-1/8" (29 mm)	CM4071BGE08	CM4071BLK08	CM4071BRN08	CM4071GRY08
1/2" (12.5 mm)	1-1/8" (29 mm)	CM4072BGE08	CM4072BLK08	CM4072BRN08	CM4072GRY08

REPLACEMENT VINYL INSERT

LENGTH: 6 ft. (1.8 m)		VINYL INSERT COLORS/PART NO.			
Height (H)	Width (W)	Beige (BGE)	Black (BLK)	Brown (BRN)	Grey (GRY)
3/8" (10 mm)	1" (25 mm)	CM4071BGE08V	CM4071BLK08V	CM4071BRN08V	CM4071GRY08V
1/2" (12.5 mm)	1" (25 mm)	CM4072BGE08V	CM4072BLK08V	CM4072BRN08V	CM4072GRY08V

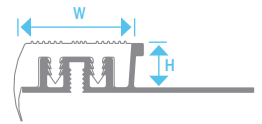
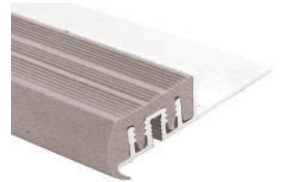

ADA Denotes ADA-compliant profiles

CERAMIC EDGE PROTECTION RAMP Pack Size: 5 pcs

Ceramic Edge Protection Ramp helps transition the edges of adjoining floor covering surfaces of unequal height.

LENGTH: 8 ft. (2.4 m)		ALUMINUM FINISH/PART NO.
Height (H)		Mill Finish (MIL)
3/8" (10 mm)		CM2551MIL08 ADA
1/2" (12.5 mm)		CM2552MIL08

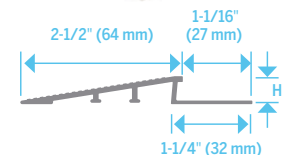

ADA Denotes ADA-compliant profiles

Notes: Colours may not appear exactly as shown. Please request sample prior to placing an order. Additionally, due to the corrosive and caustic nature of certain ingredients in many grouts, it is imperative that any residue be immediately removed from the surface of the trim to prevent discoloration.

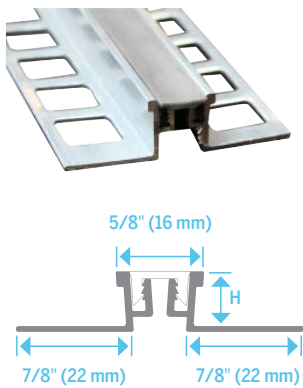

HEAVY DUTY EXPANSION JOINT Pack Size: 5 pcs

Heavy Duty Expansion Joint is great for placement over control and cold joints. Ideal for use in high-traffic, commercial applications to protect tile from cracking.

Also available in PVC on page 51.

LENGTH: 8 ft. (2.4 m)		VINYL INSERT COLORS/PART NO.	
Height (H)	Beige (BG)	Black (BK)	
3/8" (10 mm)	CM3051MIL08BG	CM3051MIL08BK	
1/2" (12.5 mm)	CM3052MIL08BG	CM3052MIL08BK	

LENGTH: 8 ft. (2.4 m)		VINYL INSERT COLORS/PART NO.	
Height (H)	Brown (BR)	Grey (GY)	
3/8" (10 mm)	CM3051MIL08BR	CM3051MIL08GY	
1/2" (12.5 mm)	CM3052MIL08BR	CM3052MIL08GY	

REPLACEMENT VINYL INSERT (FOR USE WITH CM3051 & CM3052)

VINYL INSERT COLORS/PART NO.			
Beige (BGE)	Black (BLK)	Brown (BRN)	Grey (GRY)
CM3051BGE08V	CM3051BLK08V	CM3051BRN08V	CM3051GRY08V

Notes: Colours may not appear exactly as shown. Please request sample prior to placing an order. Additionally, due to the corrosive and caustic nature of certain ingredients in many grouts, it is imperative that any residue be immediately removed from the surface of the trim to prevent discoloration.

STAINLESS STEEL TILE EDGE

The solid 304 stainless steel tile trims and corners offered within the PROVA TILE EDGE® program provide strength and durability for numerous applications without sacrificing style or finishing flare with a subtly brushed finish. Stainless steel trims are typically selected for more challenging applications where aluminum just won't do the trick. Exterior, wet and/or sanitary environments most commonly call for stainless steel due to the unique rust-resistant and inert properties of this material.

FLAT TILE EDGE Pack Size: 5 pcs

Stainless Steel Flat Tile Edge protects tile from damage while providing a finished butting edge for other flooring materials. Made of solid stainless steel for wet areas, outdoor and commercial applications. Prevents tiles from chipping and is pre-punched for easy setting into mortar.

LENGTH: 8 ft. (2.4 m)	FINISH/PART NO.
Height (H)	Stainless Steel (STS)
3/8" (10 mm)	CM2141STS08
1/2" (12.5 mm)	CM2142STS08

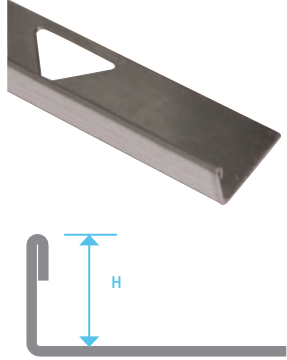
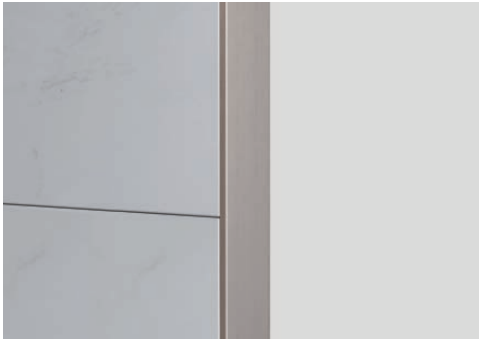

Notes: Colours may not appear exactly as shown. Please request sample prior to placing an order. Additionally, due to the corrosive and caustic nature of certain ingredients in many grouts, it is imperative that any residue be immediately removed from the surface of the trim to prevent discoloration.



ROUND TILE EDGE

Pack Size: 5 pcs

Stainless Steel Round Tile Edge protects tile from damage while providing a finished butting edge for other materials. Made of solid stainless steel for wet areas, outdoor and commercial applications. Can be used on walls, floors, countertops, and backsplashes. Prevents tiles from chipping and is pre-punched for easy setting into mortar.

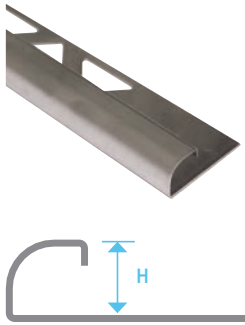

LENGTH: 8 ft. (2.4 m)		FINISH/PART NO.
Height (H)	Stainless Steel (STS)	
3/8" (10 mm)	CM2241STS08	
1/2" (12.5 mm)	CM2242STS08	



ROUND CORNERS

Pack Size: 5 pcs

Stainless Steel Round Inside and Outside Corner accessories used to finish and protect tile edges and join two pieces of round tile edge at a 90° angle.

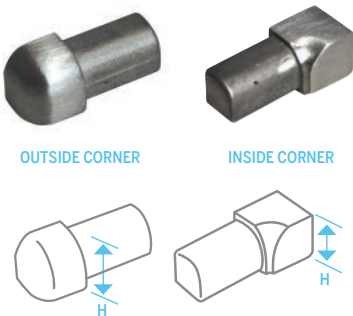

BULK		FINISH/PART NO.
Height (H)	Application	Stainless Steel (STS)
3/8" (10 mm)	Outside	CM2241STS0RC
1/2" (12.5 mm)	Outside	CM2242STS0RC
3/8" (10 mm)	Inside	CM2241STSIRC
1/2" (12.5 mm)	Inside	CM2242STSIRC

PACKAGED		FINISH/PART NO.
Height (H)	Application	Stainless Steel (STS)
3/8" (10 mm)	Outside	ET2241STS0RC
1/2" (12.5 mm)	Outside	ET2242STS0RC
3/8" (10 mm)	Inside	ET2241STSIRC
1/2" (12.5 mm)	Inside	ET2242STSIRC

Notes: Colours may not appear exactly as shown. Please request sample prior to placing an order. Additionally, due to the corrosive and caustic nature of certain ingredients in many grouts, it is imperative that any residue be immediately removed from the surface of the trim to prevent discoloration.

SQUARE TILE EDGE

Pack Size: 5 pcs

Stainless Steel Square Tile Edge provides a sleek, contemporary look to finish and protect the outer edge of exposed tile. Can be used on walls, floors, countertops, and backsplashes. This profile can also be used as an accent with feature strip or listello border. Prevents tiles from chipping and is pre-punched for easy setting into mortar.

LENGTH: 8 ft. (2.4 m)	FINISH/PART NO.
Height (H)	Stainless Steel (STS)
3/8" (10 mm)	CM2341STS08
1/2" (12.5 mm)	CM2342STS08



SQUARE CORNERS

Pack Size: 10 pcs

Stainless Steel Square Inside and Outside Corner accessories are used to finish and protect tile edges and join two pieces of square tile edge at a 90° angle.

BULK		FINISH/PART NO.
Height (H)	Application	Stainless Steel (STS)
3/8" (10 mm)	Outside	CM2341STS0RC
1/2" (12.5 mm)	Outside	CM2342STS0RC
3/8" (10 mm)	Inside	CM2341STS0RC
1/2" (12.5 mm)	Inside	CM2342STS0RC



OUTSIDE CORNER

INSIDE CORNER

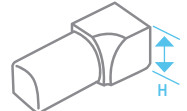
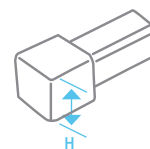

PACKAGED		FINISH/PART NO.
Height (H)	Application	Stainless Steel (STS)
3/8" (10 mm)	Outside	ET2341STS0RC
1/2" (12.5 mm)	Outside	ET2342STS0RC
3/8" (10 mm)	Inside	ET2341STS0RC
1/2" (12.5 mm)	Inside	ET2342STS0RC

Notes: Colours may not appear exactly as shown. Please request sample prior to placing an order. Additionally, due to the corrosive and caustic nature of certain ingredients in many grouts, it is imperative that any residue be immediately removed from the surface of the trim to prevent discoloration.

PVC TILE EDGE

PVC tile edge is ideal for finishing tiled surfaces, due to its durability, versatility, and great value. The PVC line of PROVA TILE EDGE profiles cut easily, protect tile from chipping, and provide functional finishing for tiled surfaces. The heavy-duty profiles can also be used on floors to protect tiles exposed to foot traffic. PVC tile edge is resistant to weather, UV rays, and most household cleaning products, making them a great option for your next project.

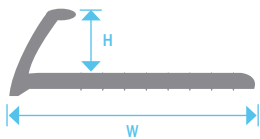
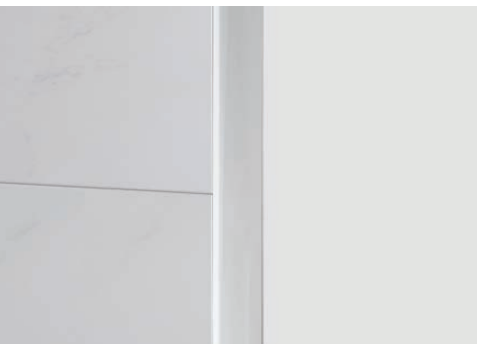

VINYL TILE EDGE

Pack Size: 50 pcs

Vinyl (PVC) Tile Edge is great for use around bathtubs, windows, backsplashes and more. Can also be used to eliminate mitering of tiles at corners, such as in step-up tubs. Pre-punched for easy setting into mortar.

LENGTH: 8 ft. (2.4 m)		RIGID VINYL COLORS/PART NO.		
Height (H)	Width (W)	Beige (BGE)	Black (BLK)	Bone (BON)
3/16" (4.5 mm)	1" (25 mm)	N/A	CT1034BLK08	CT1034BON08
1/4" (6 mm)	7/8" (22 mm)	CT1036BGE08	CT1036BLK08	CT1036BON08
3/8" (10 mm)	1" (25 mm)	CT1039BGE08	CT1039BLK08	CT1039BON08
1/2" (12.5 mm)	1" (25 mm)	CT1085BGE08	CT1085BLK08	CT1085BON08
Height (H)	Width (W)	Grey (GRY)	White (WHT)	
3/16" (4.5 mm)	1" (25 mm)	CT1034GRY08	CT1034WHT08	
1/4" (6 mm)	7/8" (22 mm)	CT1036GRY08	CT1036WHT08	
3/8" (10 mm)	1" (25 mm)	CT1039GRY08	CT1039WHT08	
1/2" (12.5 mm)	1" (25 mm)	CT1085GRY08	CT1085WHT08	

Notes: Colours may not appear exactly as shown. Please request sample prior to placing an order. Additionally, due to the corrosive and caustic nature of certain ingredients in many grouts, it is imperative that any residue be immediately removed from the surface of the trim to prevent discoloration.

VINYL J CAP

Pack Size: 50 pcs

Vinyl (PVC) J-Cap can be used as a tile edge around bathtubs, windows, backsplashes, and more.

LENGTH: 8 ft. (2.4 m)		RIGID VINYL COLORS/PART NO.	
Height (H)	Width (W)	BONE (BON)	White (WHT)
3/16" (4.5 mm)	5/8" (16 mm)	CT1024BON08	CT1024WHT08
1/4" (6 mm)	3/4" (19 mm)	CT1025BON08	CT1025WHT08
3/8" (10 mm)	3/4" (19 mm)	CT1026BON08	CT1025WHT08

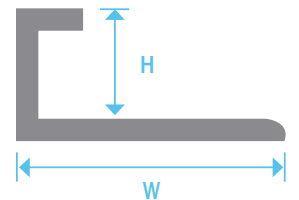

EXPANSION JOINT

Pack Size: 25 pcs

Co-extruded from rigid and flexible PVC, the Expansion Joint profile is perfect for use in tiled floor applications where flexibility is required to account for substrate movement. Ideal for use in light-duty commercial applications to protect tile from cracking. Resistant to weather, UV rays, and most household cleaning products.

Also available in Aluminum on page 46.

LENGTH: 8 ft. (2.4 m)		VINYL INSERT COLORS/PART NO.	
Height (H)		Grey (GRY)	
3/8" (10 mm)		CM3071GRY08	
1/2" (12.5 mm)		CM3072GRY08	

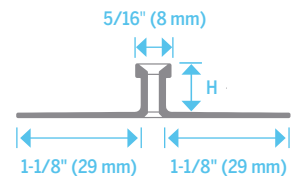

Notes: Colours may not appear exactly as shown. Please request sample prior to placing an order. Additionally, due to the corrosive and caustic nature of certain ingredients in many grouts, it is imperative that any residue be immediately removed from the surface of the trim to prevent discoloration.

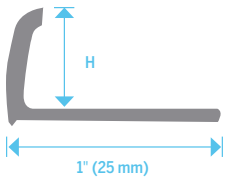
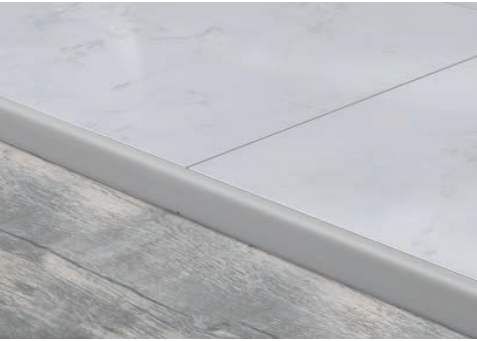

HEAVY-DUTY VINYL EDGE - FLAT

Pack Size: 50 pcs

Flat Heavy-Duty Vinyl Tile Edge is great for use around bathtubs, windows, backsplashes and more. This flat, durable profile can be used on floor tile where thinner products may not stand up to heavy traffic. Pre-punched for easy setting into mortar.

LENGTH: 8 ft. (2.4 m)

RIGID VINYL COLORS/PART NO.

Height (H)	Beige (BGE)	Black (BLK)
1/4" (6 mm)	CT1076BGE08	CT1076BLK08
5/16" (8 mm)	CT1078BGE08	CT1078BLK08
3/8" (10 mm)	CT1080BGE08	CT1080BLK08
Height (H)	Bone (BON)	Grey (GRY)
1/4" (6 mm)	CT1076BON08	CT1076GRY08
5/16" (8 mm)	CT1078BON08	CT1078GRY08
3/8" (10 mm)	CT1080BON08	CT1080GRY08
Height (H)	White (WHT)	
1/4" (6 mm)	CT1076WHT08	
5/16" (8 mm)	CT1078WHT08	
3/8" (10 mm)	CT1080WHT08	

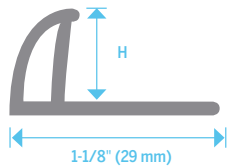
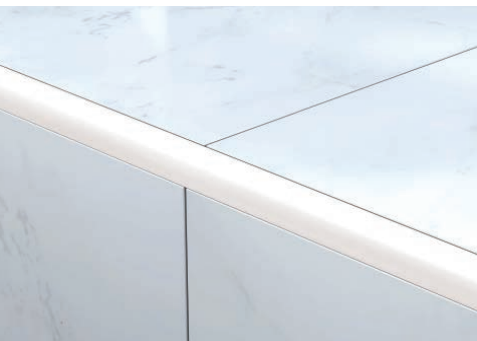

HEAVY DUTY VINYL EDGE - ROUND

Pack Size: 10 pcs

Round Heavy-Duty Vinyl Tile Edge is great for use around bathtubs, windows, backsplashes and more. This round, durable profile can be used on floor tile where thinner products may not stand up to heavy traffic. Pre-punched for easy setting into mortar.

LENGTH: 8 ft. (2.4 m)

RIGID VINYL COLORS/PART NO.

Height (H)	Beige (BGE)	Black (BLK)	Bone (BON)
5/16" (8 mm)	CT1058BGE08	CT1058BLK08	CT1058BON08
3/8" (10 mm)	CT1090BGE08	CT1090BLK08	CT1090BON08
Height (H)	Grey (GRY)	White (WHT)	
5/16" (8 mm)	CT1058GRY08	CT1058WHT08	
3/8" (10 mm)	CT1090GRY08	CT1090WHT08	

Notes: Colours may not appear exactly as shown. Please request sample prior to placing an order. Additionally, due to the corrosive and caustic nature of certain ingredients in many grouts, it is imperative that any residue be immediately removed from the surface of the trim to prevent discoloration.

HEAVY-DUTY VINYL EDGE - ROUND CORNERS Pack Size: 10 pcs

Round inside and outside corner accessories are used to finish and protect edges of tile and join two pieces of round tile edge at a 90° angle.

BULK		RIGID VINYL COLORS/PART NO.		
Height (H)	Application	Beige (BGE)	Black (BLK)	Bone (BON)
3/8" (10 mm)	Outside	CT1090BGEOCR	CT1090BLKOCR	CT1090BONOCR
Height (H)	Application	Grey (GRY)	White (WHT)	
3/8" (10 mm)	Outside	CT1090GRYOOCR	CT1090WHTOCR	

BULK		RIGID VINYL COLORS/PART NO.		
Height (H)	Application	Beige (BGE)	Black (BLK)	Bone (BON)
3/8" (10 mm)	Inside	CT1090BGEICR	CT1090BLKICR	CT1090BONICR
Height (H)	Application	Grey (GRY)	White (WHT)	
3/8" (10 mm)	Inside	CT1090GRYICR	CT1090WHTICR	

PACKAGED		RIGID VINYL COLORS/PART NO.		
Height (H)	Application	Beige (BGE)	Black (BLK)	Bone (BON)
3/8" (10 mm)	Outside	ET1090BGEOCR	ET1090BLKOCR	ET1090BONOCR
Height (H)	Application	Grey (GRY)	White (WHT)	
3/8" (10 mm)	Outside	ET1090GRYOOCR	ET1090WHTOCR	

PACKAGED		RIGID VINYL COLORS/PART NO.		
Height (H)	Application	Beige (BGE)	Black (BLK)	Bone (BON)
3/8" (10 mm)	Inside	ET1090BGEICR	ET1090BLKICR	ET1090BONICR
Height (H)	Application	Grey (GRY)	White (WHT)	
3/8" (10 mm)	Inside	ET1090GRYICR	ET1090WHTICR	

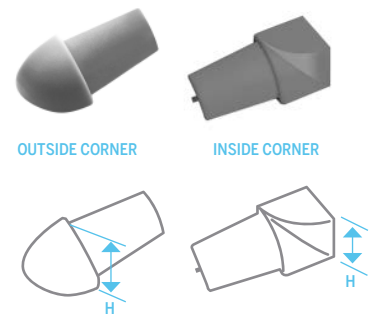

Notes: Colours may not appear exactly as shown. Please request sample prior to placing an order. Additionally, due to the corrosive and caustic nature of certain ingredients in many grouts, it is imperative that any residue be immediately removed from the surface of the trim to prevent discoloration.

ALUMINUM FINISHES*



BBR
Bright Brass



BCL
Bright Clear



HAB
Hammered Antiques Bronze



HBK
Hammered Black

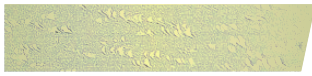

HBB
Hammered Bright Brass

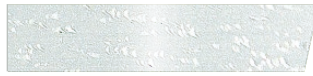

HBC
Hammered Bright Clear



HCA
Hammered Clear Anodized



HDB
Hammered Dark Bronze



HGA
Hammered Gold Anodized

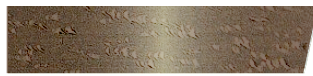

HTI
Hammered Titanium



MIL
Mill Finish



SAB
Satin Antiques Bronze



SBK
Satin Black



SCA
Satin Clear Anodized



SCP
Satin Champagne



SDB
Satin Dark Bronze



SGA
Satin Gold Anodized



STI
Satin Titanium

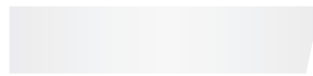

WHT
White

PVC/VINYL INSERT COLORS*



BGE
Beige



BLK
Black



BON
Bone



BRN
Brown



GRY
Grey

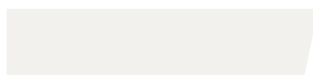

WHT
White

STAINLESS STEEL*



STS
Brushed Stainless Steel

***Notes:** Colours may not appear exactly as shown. Please request sample prior to placing an order. Additionally, due to the corrosive and caustic nature of certain ingredients in many grouts, it is imperative that any residue be immediately removed from the surface of the trim to prevent discoloration.

****Disclaimer:** DO NOT USE MILL FINISH IN WET AREAS. MILL product is aluminum in its raw state, therefore there is a high risk of oxidization on the product and staining on the tile and/or grout when it is used in wet areas.

PROVA® WARRANTIES

PROVA® Tile Installation and Waterproofing Product Warranties provide a simple and efficient method for securing warranty coverage on all your PROVA® purchases. Our straightforward eligibility requirements and transparent conditions ensure the peace of mind you expect from a warranty without the overcomplicated warranty language.

Warranty Overview

Find the right PROVA® Tile Installation and Waterproofing product warranty for your purchase below. PROVA® offers both variable term and lifetime warranties, each offering several advantages that set them apart.

The PROVA® Limited Product Warranty:

- Applies to manufacturing defects found on standalone PROVA® products
- Allows for the use of any ANSI A118.4 premium polymer-modified thinset mortar
- Assures competitive coverage for standalone PROVA® products in variable term lengths

The PROVA® Limited Lifetime Installation Warranty:

- Applies to a variety of product systems: PROVA-SHOWER® system, PROVA® Underlayment system, PROVA-MAT® system, or PROVA BOARD® PLUS system
- Allows for the use of any ANSI A118.15 premium polymer-modified thinset mortar
- Encourages installers to take full advantage of flexible, comprehensive PROVA® product systems with the confidence that their installation will last a lifetime

PROVA® Tile Installation and Waterproofing Products Limited Warranties

PROVA® Limited Warranty	Warranty Type	Warranty Duration
PROVA® Tile intallation Products	Lifetime Installation Warranty	Lifetime
PROVA® Waterproofing and Shower Products	Product Warranty	10 years
PROVA TILE EDGE®	Product Warranty	5 years
PROVA® Underlayment Products	Product Warranty	50 years

Warranty Registration Information and Exclusions

Registering your PROVA® products for warranty coverage is a simple, two-step process:

1. Purchase qualifying products.
2. Complete the appropriate registration form for your products – which can be found at www.mdpro.com/prova/warranty - within 60 days of the date of purchase. Please note that this is required to qualify for the PROVA® Tile Installation Products Limited Lifetime Warranty and encouraged for all product warranties.

Warranty Claim Information and Exclusions

To file a claim for qualifying PROVA® products and systems, simply complete the appropriate warranty claim document – which can be found at www.mdpro.com/prova/warranty - within 30 days of the alleged manufacturing defect presenting itself.

For full warranty details and exclusions, please review the warranty documents that came included with your products or visit our website at www.mdpro.com/prova/warranty.

C

CM1156BBR08.....	44	CM2150STI08.....	32	CM2171SBK08.....	40	CM2341STS08.....	49	CM4050HBC06.....	41
CM1156BCL08.....	44	CM2150STI12.....	33	CM2171SCA08.....	40	CM2342STS08.....	49	CM4050HBC12.....	41
CM1156MIL08.....	44	CM2150WHT08.....	32	CM2171SCP08.....	40	CM2342STSIRC.....	49	CM4050HCA06.....	41
CM1156SBK08.....	44	CM2150WHT12.....	33	CM2171SDB08.....	40	CM2342STS08.....	49	CM4050HCA12.....	41
CM1156SCA08.....	44	CM2151BBR08.....	32	CM2171SGA08.....	40	CM2350BCL08.....	36	CM4050HTI06.....	41
CM1156SCP08.....	44	CM2151BCL08.....	32	CM2171STI08.....	40	CM2350BCLCR.....	36	CM4050HTI12.....	41
CM1156SDB08.....	44	CM2151BCL12.....	33	CM2172BBR08.....	40	CM2350SAB08.....	36	CM4051HAB06.....	41
CM1156SGA08.....	44	CM2151MIL08.....	32	CM2172BCL08.....	40	CM2350SCA08.....	36	CM4051HAB12.....	41
CM1156STI08.....	44	CM2151SAB08.....	32	CM2172MIL08.....	40	CM2350SCACR.....	36	CM4051HBC06.....	41
CM1158SCA08.....	44	CM2151SBK08.....	32	CM2172SAB08.....	40	CM2350STI08.....	36	CM4051HBC12.....	41
CM1158STI08.....	44	CM2151SBK12.....	33	CM2172SBK08.....	40	CM2350STICR.....	36	CM4051HCA06.....	41
CM1159SCA09.....	44	CM2151SCA08.....	32	CM2172SCA08.....	40	CM2351BCL08.....	36	CM4051HCA12.....	41
CM1159STI09.....	44	CM2151SCA12.....	33	CM2172SCP08.....	40	CM2351BCLCR.....	36	CM4051HDB06.....	41
CM1160SCA09.....	44	CM2151SCP08.....	32	CM2172SDB08.....	40	CM2351SAB08.....	36	CM4051HDB12.....	41
CM1160STI09.....	44	CM2151SDB08.....	32	CM2172SGA08.....	40	CM2351SCA08.....	36	CM4051HGA06.....	41
CM2130BBR08.....	38	CM2151SGA08.....	32	CM2172STI08.....	40	CM2351SCACR.....	36	CM4051HGA12.....	41
CM2130BCL08.....	38	CM2151STI08.....	32	CM2241STS08.....	48	CM2351STI08.....	36	CM4051HTI06.....	41
CM2130MIL08.....	38	CM2151STI12.....	33	CM2241STSIRC.....	48	CM2351STICR.....	36	CM4051HTI12.....	41
CM2130SCA08.....	38	CM2151WHT08.....	32	CM2241STS08.....	48	CM2351WHT08.....	36	CM4052HAB06.....	41
CM2130SCP08.....	38	CM2151WHT12.....	33	CM2242STS08.....	48	CM2352BCL08.....	36	CM4052HAB12.....	41
CM2130STI08.....	38	CM2152BBR08.....	32	CM2242STSIRC.....	48	CM2352BCLCR.....	36	CM4052HBC06.....	41
CM2135BCL08.....	38	CM2152BCL08.....	32	CM2242STS08.....	48	CM2352SCA08.....	36	CM4052HBC12.....	41
CM2135MIL08.....	38	CM2152BCL12.....	33	CM2249BBR08.....	34	CM2352SCACR.....	36	CM4052HCA06.....	41
CM2135SCA08.....	38	CM2152MIL08.....	32	CM2249BCL08.....	34	CM2352STI08.....	36	CM4052HCA12.....	41
CM2135SAB08.....	38	CM2152SAB08.....	32	CM2249MIL08.....	34	CM2352STICR.....	36	CM4052HDB06.....	41
CM2135SDB08.....	38	CM2152SBK08.....	32	CM2249SAB08.....	34	CM2352WHT08.....	36	CM4052HDB12.....	41
CM2135SGA08.....	38	CM2152SBK12.....	33	CM2249SCA08.....	34	CM2400BCLICR.....	37	CM4052HTI06.....	41
CM2135STI08.....	38	CM2152SCA08.....	32	CM2249SGA08.....	34	CM2400BCLOCR.....	37	CM4052HTI12.....	41
CM2136BBR08.....	38	CM2152SCA12.....	33	CM2249STI08.....	34	CM2400SCAICR.....	37	CM4071BGE08.....	45
CM2136BCL08.....	38	CM2152SCP08.....	32	CM2250BBR08.....	34	CM2400SCAOCR.....	37	CM4071BGE08V.....	45
CM2136MIL08.....	38	CM2152SDB08.....	32	CM2250BCL08.....	34	CM2400STIICR.....	37	CM4071BLK08.....	45
CM2136SCA08.....	38	CM2152SDB08.....	32	CM2250MIL08.....	34	CM2400STIOCR.....	37	CM4071BLK08V.....	45
CM2136SAB08.....	38	CM2152SDB12.....	33	CM2250SAB08.....	34	CM2450BCL08.....	37	CM4071BRN08.....	45
CM2136SDB08.....	38	CM2152STI08.....	32	CM2250SBK08.....	34	CM2450SCA08.....	37	CM4071BRN08V.....	45
CM2136SGA08.....	38	CM2152STI12.....	33	CM2250SCA08.....	34	CM2450STI08.....	37	CM4071GRY08.....	45
CM2136STI08.....	38	CM2152WHT08.....	32	CM2250SCA08.....	34	CM2451BCL08.....	37	CM4071GRY08V.....	45
CM2141STI08.....	47	CM2152WHT12.....	33	CM2250SCP08.....	34	CM2451SCA08.....	37	CM4072BGE08.....	45
CM2142STS08.....	47	CM2154BCL08.....	32	CM2250SDB08.....	34	CM2451STI08.....	37	CM4072BGE08V.....	45
CM2148MIL08.....	32	CM2154MIL08.....	32	CM2250SGA08.....	34	CM2452BCL08.....	37	CM4072BLK08.....	45
CM2148SCA08.....	32	CM2154SBK08.....	32	CM2250STI08.....	34	CM2452SCA08.....	37	CM4072BLK08V.....	45
CM2148STI08.....	32	CM2154SCA08.....	32	CM2251BBR08.....	34	CM2452STI08.....	37	CM4072BRN08.....	45
CM2149BCL08.....	32	CM2154SCP08.....	32	CM2251BCL08.....	34	CM2551MIL08.....	45	CM4072BRN08V.....	45
CM2149MIL08.....	32	CM2154STI08.....	32	CM2251MIL08.....	34	CM2552MIL08.....	45	CM4072GRY08.....	45
CM2149SAB08.....	32	CM2155BCL08.....	32	CM2251SAB08.....	34	CM3051BGE08V.....	46	CM4072GRY08V.....	45
CM2149SBK08.....	32	CM2155MIL08.....	32	CM2251SBK08.....	34	CM3051BLK08V.....	46	CM4151BCL08.....	42
CM2149SCA08.....	32	CM2155SBK08.....	32	CM2251SCA08.....	34	CM3051BRN08V.....	46	CM4151CAP08.....	42
CM2149SDB08.....	32	CM2155SCA08.....	32	CM2251SCP08.....	34	CM3051GRY08V.....	46	CM4151SBK08.....	42
CM2149SGA08.....	32	CM2155SCP08.....	32	CM2251SDB08.....	34	CM3051MIL08BG.....	46	CM4151SCA08.....	42
CM2149STI08.....	32	CM2155STI08.....	32	CM2251STI08.....	34	CM3051MIL08BK.....	46	CM4151SDB08.....	42
CM2149WHT08.....	32	CM2170BCL08.....	40	CM2251WHT08.....	34	CM3051MIL08BR.....	46	CM4151STI08.....	42
CM2150BBR08.....	32	CM2170MIL08.....	40	CM2252BBR08.....	34	CM3051MIL08GY.....	46	CM4152SCA08.....	43
CM2150BCL08.....	32	CM2170SAB08.....	40	CM2252BCL08.....	34	CM3052MIL08BG.....	46	CM4152SCAICR.....	43
CM2150BCL12.....	33	CM2170SBK08.....	40	CM2252MIL08.....	34	CM3052MIL08BK.....	46	CM4152SCAICR.....	43
CM2150MIL08.....	32	CM2170SCA08.....	40	CM2252SAB08.....	34	CM3052MIL08BR.....	46	CM4152SCAOCR.....	43
CM2150SAB08.....	32	CM2170SCP08.....	40	CM2252SBK08.....	34	CM3052MIL08GY.....	46	CM4152STI08.....	43
CM2150SBK08.....	32	CM2170SDB08.....	40	CM2252SCA08.....	34	CM3071GRY08.....	51	CM4152STIOCR.....	43
CM2150SBK12.....	33	CM2170SGA08.....	40	CM2252SCP08.....	34	CM3072GRY08.....	51	CM4153SCA08.....	43
CM2150SCA08.....	32	CM2170STI08.....	40	CM2252SDB08.....	34	CM4050HAB06.....	41	CM4153SCAICR.....	43
CM2150SCA12.....	33	CM2171BBR08.....	40	CM2252STI08.....	34	CM4050HAB12.....	41	CM4153SCAICR.....	43
CM2150SCP08.....	32	CM2171BCL08.....	40	CM2252WHT08.....	34	CM4050HBB06.....	41	CM4153SCAOCR.....	43
CM2150SDB08.....	32	CM2171MIL08.....	40	CM2341STS08.....	49	CM4050HBB12.....	41	CM4153STI08.....	43
CM2150SGA08.....	32	CM2171SAB08.....	40	CM2341STSIRC.....	49				

CM4153STIOCR.....	43	CT1058BON08.....	52	ET2351BCLCR.....	36	TT8007NOG03.....	10	TT8409BRS05ES.....	6
CM4251HAB06.....	41	CT1058GRY08.....	52	ET2351SCACR.....	36	TT8007STS03.....	10	TT8409BRZ05.....	6
CM4251HAB12.....	41	CT1058WHT08.....	52	ET2351STICR.....	36	TT8008PAN04.....	8	TT8409BRZ05ES.....	6
CM4251HBC06.....	41	CT1076BGE08.....	52	ET2352BCLCR.....	36	TT8011EXT04.....	8	TT8409CRM05.....	6
CM4251HBC12.....	41	CT1076BLK08.....	52	ET2352SCACR.....	36	TT8012CRB60.....	9	TT8409CRM05ES.....	6
CM4251HBC06.....	41	CT1076BON08.....	52	ET2352STICR.....	36	TT8013PAN02.....	8	TT8409GRH05.....	6
CM4251HBK12.....	41	CT1076GRY08.....	52	ET2400BCLICR.....	37	TT8015CRB48.....	9	TT8409GRH05ES.....	6
CM4251HCA06.....	41	CT1076WHT08.....	52	ET2400BCLOCOR.....	37	TT8102REDPS.....	21	TT8409STS05.....	6
CM4251HCA12.....	41	CT1078BGE08.....	52	ET2400SCAICR.....	37	TT8102REDPSB.....	21	TT8409STS05ES.....	6
CM4251HDB06.....	41	CT1078BLK08.....	52	ET2400SCAOCR.....	37	TT8107NOG03.....	10	TT8509BRS05.....	6
CM4251HDB12.....	41	CT1078BON08.....	52	ET2400STICR.....	37	TT8107STS03.....	10	TT8509BRS05ES.....	6
CM4251HGA06.....	41	CT1078GRY08.....	52	ET2400STIOCR.....	37	TT8113PAN02.....	8	TT8509BRZ05.....	6
CM4251HGA12.....	41	CT1078WHT08.....	52	ET5008SABIC.....	35	TT8114PAN05.....	13	TT8509BRZ05ES.....	6
CM4251HTI06.....	41	CT1080BGE08.....	52	ET5008SABOC.....	35	TT8115EXT04.....	13	TT8509CRM05.....	6
CM4251HTI12.....	41	CT1080BLK08.....	52	ET5008SCAIC.....	35	TT8204BLK04.....	11	TT8509CRM05ES.....	6
CM4551SBK12.....	42	CT1080BON08.....	52	ET5008SCAOC.....	35	TT8204BRS04.....	11	TT8509GRH05.....	6
CM4551SCA12.....	42	CT1080GRY08.....	52	ET5008STIC.....	35	TT8204BRZ04.....	11	TT8509GRH05ES.....	6
CM4551STI12.....	42	CT1080WHT08.....	52	ET5008STIOC.....	35	TT8204CRM04.....	11	TT8509STS05.....	6
CM4552SBK12.....	42	CT1085BGE08.....	50	ET5110SABIC.....	35	TT8204GRH04.....	11	TT8509STS05ES.....	6
CM4552SCA12.....	42	CT1085BLK08.....	50	ET5110SABOC.....	35	TT8204STS04.....	11	TT8800NCH16.....	24
CM4552STI12.....	42	CT1085BON08.....	50	ET5110SCAIC.....	35	TT8206BRS05.....	6	TT8800NCH33.....	24
CM5008SABIC.....	35	CT1085GRY08.....	50	ET5110SCAOC.....	35	TT8206BRS05ES.....	6	TT8801INCH24.....	24
CM5008SABOC.....	35	CT1085WHT08.....	50	ET5110STIIC.....	35	TT8206BRZ05.....	6	TT8810GSS12.....	24
CM5008SCAIC.....	35	CT1090BGE08.....	52	ET5110STIOC.....	35	TT8206BRZ05ES.....	6	TT8900TNT24.....	16
CM5008SCAOCR.....	35	CT1090BGEICR.....	53	ET5212SABIC.....	35	TT8206CRM05.....	6	TT8900TNT36.....	16
CM5008STIIC.....	35	CT1090BGEOCR.....	53	ET5212SABOC.....	35	TT8206CRM05ES.....	6	TT8900TNT42.....	16
CM5008STIOCR.....	35	CT1090BLK08.....	52	ET5212SCAIC.....	35	TT8206GRH05.....	6	TT8901PAN02.....	16
CM5110SABIC.....	35	CT1090BLKICR.....	53	ET5212SCAOC.....	35	TT8206GRH05ES.....	6	TT8902EXT02.....	17
CM5110SABOC.....	35	CT1090BLKOCR.....	53	ET5212STIIC.....	35	TT8206STS05.....	6	TT8903CTRO4.....	17
CM5110SCAIC.....	35	CT1090BON08.....	52	ET5212STIOC.....	35	TT8206STS05ES.....	6	TT8903END02.....	17
CM5110SCAOCR.....	35	CT1090BONICR.....	53	P		TT8209BRS05.....	6	TT8910STS24.....	16
CM5110STIIC.....	35	CT1090BONOCR.....	53	PBS10FLOCDN.....	25	TT8209BRS05ES.....	6	TT8910STS36.....	16
CM5110STIOCR.....	35	CT1090GRY08.....	52	PBS10FLOZUS.....	25	TT8209BRZ05.....	6	TT8910STS42.....	16
CM5212SABIC.....	35	CT1090GRYICR.....	53	PVBP24X48X12.....	22	TT8209BRZ05SE.....	6		
CM5212SABOC.....	35	CT1090GRYOCR.....	53	PVBP24X96X20.....	22	TT8209CRM05.....	6		
CM5212SCAIC.....	35	CT1090WHT08.....	52	PVBP36X60X05.....	22	TT8209CRM05ES.....	6		
CM5212SCAOCR.....	35	CT1090WHTICR.....	53	PVBP36X60X05B.....	22	TT8209GRH05.....	6		
CM5212STIIC.....	35	CT1090WHTOCR.....	53	PVBP36X60X25.....	22	TT8209GRH05SE.....	6		
CM5212STIOCR.....	35	E		PVBP48X96X05.....	22	TT8209STS05.....	6		
CT1024BON08.....	51	ET1090BGEICR.....	53	PVBP48X96X05B.....	22	TT8209STS05ES.....	6		
CT1024WHT08.....	51	ET1090BGEOCR.....	53	PVBP48X96X58B.....	22	TT8306BRS05.....	6		
CT1025BON08.....	51	ET1090BLKICR.....	53	PVBP8008ABS.....	23	TT8306BRS05ES.....	6		
CT1025WHT08.....	51	ET1090BLKOCR.....	53	PVBP8008PVC.....	23	TT8306BRZ05.....	6		
CT1025WHT08.....	51	ET1090BLKOCR.....	53	PVBP8013ABS.....	23	TT8306BRZ05ES.....	6		
CT1026BON08.....	51	ET1090BONICR.....	53	PVBP8013PVC.....	23	TT8306CRM05.....	6		
CT1026BON08.....	51	ET1090BONOCR.....	53	T		TT8306CRM05ES.....	6		
CT1034BLK08.....	50	ET1090GRYICR.....	53	TT8000RED82R.....	29	TT8306GRH05.....	6		
CT1034BON08.....	50	ET1090GRYOCR.....	53	TT8001RED25R.....	20	TT8306GRH05ES.....	6		
CT1034GRY08.....	50	ET1090WHTICR.....	53	TT8001RED82R.....	20	TT8306STS05.....	6		
CT1034WHT08.....	50	ET1090WHTOCR.....	53	TT8002RED05R.....	20	TT8309BRS05.....	6		
CT1036BGE08.....	50	ET2241STSIRC.....	48	TT8002RED05R.....	20	TT8309BRS05ES.....	6		
CT1036BLK08.....	50	ET2242STSIRC.....	48	TT8002RED10R.....	20	TT8309BRZ05.....	6		
CT1036BON08.....	50	ET2242STSORC.....	48	TT8002RED25R.....	20	TT8309BRZ05ES.....	6		
CT1036GRY08.....	50	ET2341STSIRC.....	49	TT8003INSCR.....	21	TT8309CRM05.....	6		
CT1036WHT08.....	50	ET2341STSORC.....	49	TT8003OUTCR.....	21	TT8309CRM05ES.....	6		
CT1039BGE08.....	50	ET2342STSIRC.....	49	TT8004RED05.....	29	TT8309GRH05.....	6		
CT1039BLK08.....	50	ET2342STSORC.....	49	TT8004RED82R.....	29	TT8309GRH05ES.....	6		
CT1039BON08.....	50	ET2350BCLCR.....	36	TT8006RED05.....	28	TT8309STS05.....	6		
CT1039GRY08.....	50	ET2350SCACR.....	36	TT8006RED10.....	28	TT8309STS05ES.....	6		
CT1039WHT08.....	50	ET2350STICR.....	36	TT8006RED15.....	28	TT8409BRS05.....	6		
CT1058BGE08.....	52								
CT1058BLK08.....	52								



A division of M-D Building Products
5720 Ambler Drive
Mississauga, ON, L4W 2B1
1 800 565 6653
service@mdteam.com

Technical Service Hotline:
1 888 MDPROVA (1 888 637 7682)

   www.provaproducts.com

